

# TPW E-FORCE

Pallet truck scale with electric traction tiller

USER AND MAINTENANCE INSTRUCTIONS

ENGLISH

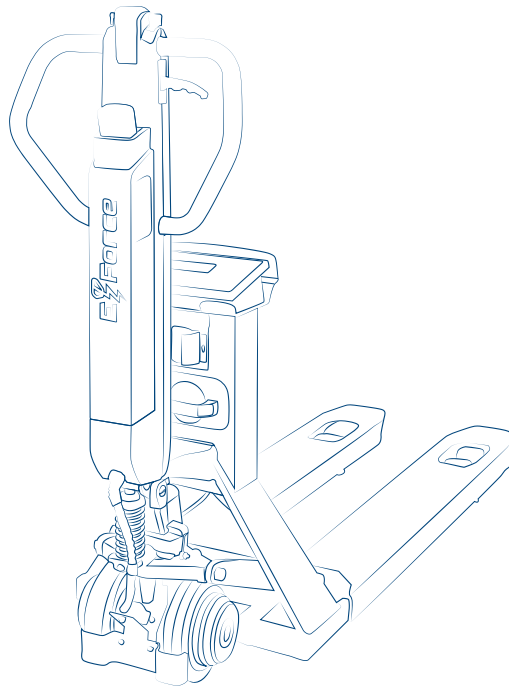



## Index

<b>INTRODUCTION</b>	<b>7</b>
<b>IDENTIFICATION</b>	<b>9</b>
Identification of the Manufacturer	9
Machine identification	9
Identification plate	9
EC Declaration of Conformity	10
Reference directives	11
<b>PRELIMINARY INFORMATION</b>	<b>12</b>
Recipients	12
Supply and storage	12
Updates	12
Language	13
Operators	13
Personal protective equipment	14
Warranty	15
<b>SAFETY DEVICES</b>	<b>16</b>
Noise	16
Vibrations	16
Risks	16
Safety pictograms applied to the machine	19
<b>DESCRIPTION</b>	<b>20</b>
Intended use (correct)	20
Reasonably foreseeable misuse	20
Obligations and prohibitions	21
Operator obligations	21
Operator prohibitions	21
Technical data	22
Environmental conditions permitted	23

Main components	24
-----------------	----

## **PACKAGING AND HANDLING** **27**

---

Packaging and handling warnings	27
Packaging	28
Packaging handling	28

## **ASSEMBLY** **29**

---

Descent adjustment	29
Tiller sensor calibration	30

## **COMMANDS** **31**

---

Tiller commands	31
Tiller display	33
Weight indicator display	34
Keyboard types	35

## **USE** **37**

---

General warnings for correct weighing	37
Safety standards	39
Preventive checks	40
Route	41
Parking	41
Towing or pushing	41
Change of direction	41
Handling of loads	42
Load stability	42
Load positioning	42
Operations with the load	42
Operations without the load	43
Driving rules	43
Pallet truck conditions	47
Display switch-on	48
Pallet truck positioning	49

Load lifting and weight reading	49
How to replace the roll	50
Customisable printouts	50

## **BASIC SCALE FUNCTIONS** **51**

---

Start-up - On	51
Shutdown - Off	51
Zero	51
Display brightness adjustment	52
Automatic tare	52
Tare deletion	53
Set a known tare value (PT)	53
Print	54
Metrics	55

## **ADDITIONAL FUNCTIONS FOR MODELS WITH NUMBER KEYPAD** **56**

---

30-tare log	56
Automatic tare deletion	57
Number IDs	58
Date and time	59
Print (and reprint of last receipt)	60
Metrics	61

## **ADVANCED SCALE FUNCTIONS** **62**

---

How to access the function menu	62
Horizontal accumulator	63
Mixing several components	65
Piece count	67
Weight check	70
Exchange between net weight and gross weight	74
Percentage weighing	75
Unit of measurement conversion	78

## **METROLOGICAL SCALE INFORMATION** **80**

---

## **MAINTENANCE** **81**

---

Maintenance warnings	81
Scheduled maintenance	82
Scheduled maintenance table	82
Oil level top-up	83
Tank top-up by means of syringe for models with mono-block pump	83
Unscheduled maintenance	84

## **TROUBLESHOOTING CASES** **85**

---

Error messages	87
----------------	----

## INTRODUCTION

This manual contains all the instructions for the use of the machine and the necessary knowledge for its correct use. While thanking you for buying our truck we would like to draw your attention to some important aspects of this manual:

- This booklet gives useful indications for the correct use and maintenance of the fork lift truck to which it refers; it is, therefore, essential to pay great attention to all the paragraphs that illustrate the simplest and safest way of using the truck;
- This booklet must be considered an integral part of the truck and should be included at the moment of sale.
- No part of this publication may be reproduced without the written authorisation of the manufacturer.
- All the information contained in this booklet is based on the data available at the time of printing; the manufacturer reserves the right to modify its products at any time, without notice and without liability.

It is therefore advisable to regularly check for any changes.

## Safety messages

---

“Self-propelled forklift” means any vehicle equipped with wheels (except those circulating on rails) designed to transport, tow, push, lift, stack or place any type of load on a rack and driven by an operator moving along with the forklift or on board the same, on a seat or a specific platform.

The TPW E-FORCE forklift is a type of self-propelled industrial vehicle called “electric pallet truck”, a non-stacker forklift equipped with forks, driven by an operator on foot, whose purpose is to lift a load off the ground on a standardized pallet or container so it can be transported.

THE PERSONNEL APPOINTED BY THE COMPANY OWNING THE FORKLIFT IS OBLIGED TO FOLLOW THE GENERAL PROVISIONS OF THIS DOCUMENT FOR THE PURPOSES OF COMPLIANCE WITH SAFETY REGULATIONS.



THE FORKLIFT USE AND MAINTENANCE MANUAL MUST ALWAYS BE AVAILABLE TO THE OPERATOR

The operator has the obligation to prevent the use of the forklift by untrained personnel and must take away the starting keys when leaving the forklift, in order to prevent its use by others. It is advisable to provide only authorized operators with keys.

The Employer, through the Supervisors of its Company, must ensure compliance with these provisions.

The Supervisors of the Company must comply with the following provisions:

- Ensure that the operators have good psychophysical characteristics.
- Make sure that the operators know how to use of the forklift and have read this user manual.

The operator and the maintenance technician must perform routine maintenance as indicated in this manual in the dedicated chapter. The operator and the person in charge of maintenance have the obligation to ask the Supervisor the intervention of the manufacturer technical assistance for the extraordinary maintenance indicated in this manual.

The operator is obliged not to use the forklift while any defect is present.



## IT IS FORBIDDEN TO PERFORM EXTRAORDINARY REPAIRS OR MAINTENANCE

All interventions performed by personnel not authorized by the manufacturer, with the exception of those expressly described in this use and maintenance manual, are prohibited.

Any repairs or extraordinary maintenance performed on one's own or in unauthorized workshops can cause malfunctions which can consequently cause damage to people or property. In such cases, the manufacturer is relieved of any responsibility for compliance with general safety regulations.

The repairer or maintenance technician (other than the manufacturer technician) assumes responsibility for compliance with the safety regulations for the whole machine and the technical file held by the manufacturer is not to be considered representative of the machine in its entire context.

Any repairs or extraordinary maintenance performed on one's own or in unauthorized workshops, during the entire warranty period, automatically invalidate the warranty.

The use of special equipment not built and installed by the manufacturer can change the conditions of use of the machine.

It is mandatory to submit the installation of equipment directly to the manufacturer, for possible approval.

Failure to comply with this rule indemnifies the manufacturer from any liability, as already indicated for repairs or extraordinary maintenance. Special equipment installed directly by the manufacturer will be documented with what is necessary for compliance with safety standards.

The instructions for use and maintenance of the forklift with special equipment will be attached to this documentation.

## ACCOMPANYING DOCUMENTATION

The forklift is supplied with accompanying documents in order to guarantee the reliable identification of the same and to indicate the correct conditions of use and maintenance. Upon receipt of the forklift, it is essential to verify the correctness of the purchase documents and verify the presence of the following documents:

- DECLARATION OF CONFORMITY
- USE AND MAINTENANCE MANUAL

In the absence of one or more of the documents mentioned above, it is essential to notify the dealer from which the forklift was purchased. In case of failure to supply the accompanying documents, it is forbidden to use the forklift.

The documents are available in digital format at [www.diniargeo.com](http://www.diniargeo.com). The printing of these documents is the responsibility of the dealer.



## IDENTIFICATION

### Identification of the Manufacturer

---

Manufacturer     **Dini Argeo s.r.l.**  
Address           **Via della Fisica, 20**  
                      **41042 Spezzano di Fiorano Mod.se (MO) - Italy**  
                      **Tel. +39 0536 843418   Fax +39 0536 843521**  
                      **info@diniargeo.com**

### Machine identification

---

Machine           **PALLET TRUCK SCALE WITH ELECTRIC TRACTION TILLER**  
Model             **TPWE-FORCE**

### Identification plate

---

The machine is equipped with an identification plate positioned in the upper part of the column.

The identification details of the machine, to be cited to the Support Centre if required, are provided on the plate.

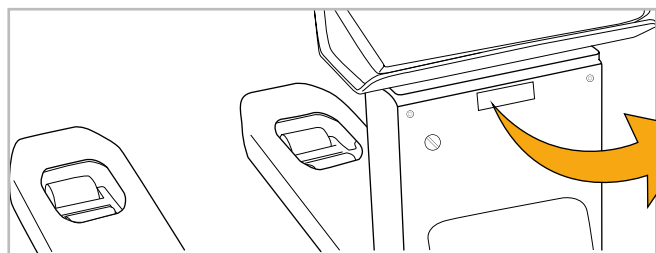

Mod.	TPWE-FORCE	0200-NAWI-06083	
Sn	0123456789	0200-WL-05741	
Max B1W1	1200 kg		
Min	2 kg		
e=	0,1 kg		
Dini Argeo - v. Fisica, 20 - 41042 Fiorano (MO) Italy			



#### **WARNING!**

It is strictly forbidden to remove the CE identification plate and/or replace it with other plates.

If, for accidental reasons, the plate is damaged or removed, the customer must inform the Manufacturer.



## Reference directives

---

The machine supplied by **DINI ARGEO** does not fall within one of the categories of machines listed in Annex IV of the Directive; therefore, for the purposes of certifying conformity of the machinery with the provisions of this Directive, **DINI ARGEO** shall apply the conformity assessment procedure with internal check on the manufacture of the machinery, as set out in Annex VIII.

To certify the conformity of the machine with the provisions of the Directive, **DINI ARGEO** before placing it on the market, has carried out the risk assessment in order to verify compliance with the essential health and safety requirements of the Directive as well as the tests and the checks required by the reference standards applied.

The technical construction file has been compiled in compliance with the provisions of Annex VII of **Directive 2006/42/EC** and is available for inspection by supervisory authorities upon a reasoned request, as required by the laws in force on the matter.

ss then places the machine on the market, constituting it with:

- CE Marking
- EC Declaration of Conformity
- Instruction manual for use, installation and maintenance (Documentation drawn up according to section 1.7.4 of the Machinery Directive 2006/42/EC)

please note that the machine has been designed according to the following Directives:

- **2006/42/EC Machinery Directive**
- **2014/30/EU Electromagnetic Compatibility Directive**

And that the following harmonised standards have been applied:

- **EN 61000-6-2 / 2005**
- **EN 61000-6-4 / 2007 / A1:2011**
- **EN 61326-1 / 2013**
- **EN 55011 / 2009**
- **UNI EN 13155 / 2009**
- **UNI EN 13889**

# PRELIMINARY INFORMATION

## Recipients

---

The manual is intended for operators responsible for using and managing the machine throughout all its technical lifespan stages. It contains the topics referring to the correct use of the machine, in order to maintain its functional and qualitative characteristics unchanged over time. All information and warnings for correct use in complete safety are also provided.

The manual, similarly to the EC compliance certificate, is an integral part of the machine and must always accompany it if moved or resold. It is the responsibility of the user to keep this documentation intact, to allow consultation, throughout the lifespan of the machine itself.

## Supply and storage

---

The manual is available in electronic **format** on: [www.diniargeo.com](http://www.diniargeo.com)

Store this manual supplied with the machine, in order for it to be easily consulted by the operator.

The manual is an integral part for safety purposes, therefore:

- **it must be kept intact** (in all its parts). Should it be lost or damaged, it is required to request a copy immediately.
- **it must follow the machine until demolition** (even in case of movements, sale, lease, rental, etc....);

**DINI ARGEO** declines any liability for improper use of the machine and/or damage caused as a result of operations not covered by the technical documentation.

## Updates

---

Should the machine require functional modifications or replacements, the revision or update of the manual is the responsibility of the Manufacturer. The Manufacturer is responsible for the delivery of the update of the manual.

The user is also responsible for ensuring that, if the present document is modified by the Manufacturer, only the updated versions of the manual are actually present in the points of use.

## Language

---

The original manual has been drawn up in **Italian**.

Any translations into additional languages must be carried out starting from the original instructions.

The Manufacturer considers himself responsible for the information contained in the original instructions; translations in different languages cannot be fully verified, therefore if an incongruity is detected, it is required to follow the original text or contact the Support Centre.

## Operators

---





In order to establish with certainty what are the skills and qualifications of the operators involved in the various tasks (commissioning, cleaning, scheduled maintenance), refer to the following table:

Qualification	Description
<b>OPERATOR</b>	<p>Personnel of the user trained and qualified to use and run the machine for production purposes for the activities for which it was built and supplied.</p> <p>They must be able to perform all the operations required for proper functioning of the machine and for the safety of themselves or of any collaborators. They must have proven experience in the correct use of these types of machines and be trained, informed and instructed in this regard. In case of doubt, they must report any anomaly to their superior.</p> <p><b>Note:</b> they are not authorised to carry out any maintenance operation.</p>
<b>MECHANICAL MAINTENANCE TECHNICIAN</b>	<p>Qualified technician able to perform preventive/corrective maintenance on all mechanical parts of the machine subject to maintenance or repair.</p> <p>Qualified technician able to access all machine parts for visual analysis, checking the equipment status, adjustments and calibrations.</p> <p><b>Note:</b> they are not authorised to operate on live electrical systems (if any).</p>
<b>MANUFACTURER'S TECHNICIAN</b>	<p>Technician qualified by the Manufacturer and/or their distributor for complex operations, as they are aware of the production cycle of the machine.</p> <p>This person operates according to the user's requests.</p>

## Personal protective equipment

When working near the machine, both for assembly operations and for maintenance and/or adjustment, it is strictly required to comply with the general accident-prevention regulations, therefore it will be important to use the **personal protective equipment (PPE)** required for each individual operation.

The complete list of **personal protective equipment (PPE)** that may be required for the different procedures is provided below:

Symbol	Description
	<b>Obligation to use safety or insulating gloves.</b> Indicates a requirement for the personnel to use safety or insulating gloves.
	<b>Obligation to use safety goggles.</b> Indicates a requirement for the personnel to use safety goggles.
	<b>Obligation to use safety footwear.</b> Indicates a requirement for the personnel to use safety footwear.
	<b>Obligation to use noise protection devices.</b> Indicates a requirement for the personnel to use earplugs or earmuffs for hearing protection.
	<b>Obligation to use safety clothing.</b> Indicates a requirement for the personnel to wear the specific safety clothing.

The clothing of those operating or maintaining the line must comply with the essential safety requirements defined by the **EU Reg.2016/425** and with the laws in force in the country where the line is installed.

## Warranty

---



### IMPORTANT!

The complete warranty terms are set out in the sales contract.

The conditions foreseen in the commercial contract (if different) have priority over what is provided in this section.

The warranty is **subject** to the following general conditions:

- the machine must be used within the limits stated in the contract and provided in the technical documentation.
- maintenance must be carried out in the times and in the ways required by the manual, using original **DINI ARGEO** spare parts and entrusting the operations to qualified personnel.

The warranty is **void** in case of:

- failure to comply with the safety regulations;
- removal or tampering with control and safety devices;
- improper use of the machine;
- use of the machine by untrained and/or unauthorised personnel or failure to comply with the skills of the various operators, as indicated in the manual;
- modifications or repairs made by the user without the Manufacturer's written authorisation;
- partial or total failure to comply with the instructions;
- lack of maintenance;
- use of non-original spare parts;
- exceptional events such as flooding, fires (if not caused by the machines).

## SAFETY DEVICES

### Noise

---

Noise measurements have been carried out in accordance with the provisions of standards **UNI EN 11200** and **UNI EN ISO 3746**.

During the operating cycles, under conditions of perfect functioning and maintenance and on a smooth industrial surface, **noise exposure of the personnel is less than 70 dB**.

**It is the user's responsibility to apply the resulting preventive and protective measures, in compliance with the legislation of the country where the machine is installed and used.**

### Vibrations

---

The vibrations produced by the machine, according to its mode of operation, **are not dangerous** to the health of the operators.



**WARNING!**

**Excessive vibration can only be caused by a mechanical fault that must be immediately reported and eliminated, in order not to compromise the safety of the line and of the operators.**

### Risks

---

The machine has been designed to assure the essential safety requirements for the operator.

Safety has been integrated into the design and construction of the machine as far as possible; however, risks from which operators must be protected remain.





For each residual risk, a description of the risk and of the zone or part of the machine subject to the residual risk is provided (unless it is a risk valid for the entire machine). Procedural information on how to avoid the risk and on the correct use of the personal protection devices provided and required by the Manufacturer is also provided.

Risk	Description and procedural information
<b>Risk of crushing</b>	The risk of crushing lower limbs under the load during its descent remains.
<b>Risk of load falling</b>	The risk of load falling and crushing during handling operations remains.



## Safety messages

In order to safeguard the user safety and ensure the correct operation of the forklift, this use and maintenance manual contains the safety messages indicated below. In the case of messages “**DANGER**”, “**WARNING**” and “**CAUTION**”, the safety message is composed of a symbol (a triangle containing an exclamation point) followed by the text indicating the level of risk and is intended to alert the user about the potential damage that may result from the incorrect use of the forklift or failure to comply with the instructions for use and maintenance. Failure to comply with these safety messages could cause damage and/or the partial or total destruction of the product or other equipment connected to the same, or harm people. In the case of the “**NOTICE**”, the safety message is composed exclusively of the text (without any symbol) and does not indicate specific risks, but simply provides a piece of information.

PICTOGRAM	DESCRIPTION
 <b>DANGER</b>	Indicates an imminent risk situation which, if not avoided, <b>causes death or serious damage</b> (e.g. amputations, severe burns, loss or deterioration of vision or hearing).
 <b>WARNING</b>	Indicates a situation of potential risk which, if not avoided, <b>can cause death or serious damage</b> (e.g. amputations, severe burns, loss or deterioration of vision or hearing).
 <b>CAUTION</b>	Indicates a situation of potential risk which, if not avoided, <b>may cause minor damage</b> (e.g. cuts, scratches, irritation).
 <b>NOTICE</b>	It is used for practices not related to physical injuries.

These symbols indicate the presence of a risk: the non-observance of the safety rules and the related indications can cause danger to people and property. A general risk is defined as the possibility of damage due to significant dangers such as:

- Tipping
- Fall of the load
- Explosion
- Crushing
- Electrocution.

Operators, maintenance personnel and anyone operating near the forklift are exposed to these risks.

### RISKS FROM INCORRECT USE

To operate in safe conditions, it is necessary to comply with the following instructions and to deal with dangerous situations with caution.

### GENERAL RISK, LIMITATIONS OF USE TO PERSONS OTHER THAN THE OPERATOR.

The operator has the obligation to prevent the use of the forklift by third parties by removing the key when moving away from the machine. When remaining near the forklift, with inserted keys, the operator will have to take care that no one accesses the controls.

### **GENERAL RISK CAUSED BY NON-KNOWLEDGE OF THE MACHINE**

The operator is required to have a thorough knowledge of the forklift, carefully study the instructions for use and work only with loads that do not exceed the capacity indicated on the plate.

### **GENERAL RISK CAUSED BY NON-KNOWLEDGE OF THE LOAD**

The operator is required to know the stacking nature and state of the carried load. The operator has the right to refuse to transport loads which in his/her opinion are dangerous for the environments that must be crossed, or in any case are badly stacked.

### **GENERAL RISK CAUSED BY NON-KNOWLEDGE OF THE ENVIRONMENT**

The operator is required to know the presence, in the environments he/she must cross, of pollutants dangerous to humans or that can cause explosions due to incompatibility with the truck or which may react to the nature of the load. The presence of holes, bumps or obstacles along the route can cause risks for the operator or the truck. The handling areas and routes must be adequately paved, leveled and free from obstacles. The operator has the right to refuse to go through environments on routes that are dangerous for humans or the forklift. The operator has the right to refuse to transport loads which in his/her opinion are dangerous for the environments to be crossed.

### **GENERAL RISK CAUSED BY INCORRECT MAINTENANCE**

The operator and the maintenance technician are required to know the maintenance program and to carry out routine maintenance scrupulously. In the case of ordinary maintenance entrusted to different operators of their company, they must ensure that the program is rigorously followed and that the work is carried out scrupulously. Extraordinary maintenance must always be entrusted to workshops authorized by the manufacturer.

### **GENERAL RISK CAUSED BY NON-COMPLIANT CLOTHING**

The operator of the forklift is obliged to use clothing that reduces the possibility of danger. We recommend using safety shoes, gloves, trousers and close-fitting jackets. The use of watches and metal jewelry is not recommended, since they could cause short circuits near the battery. In addition, use adequate protection in the presence of aggressive environments.

**Read the instructions for use carefully.**

## Safety pictograms applied to the machine

Stickers and safety plates are applied to the machine, as shown in the following table. Refer to the image for positioning.

Pos.	Pictogram	Description
1		CE IDENTIFICATION PLATES
2		WARNING PLATE
3		MANUFACTURER DATA STICKER
4		BATTERY INDICATIONS STICKER

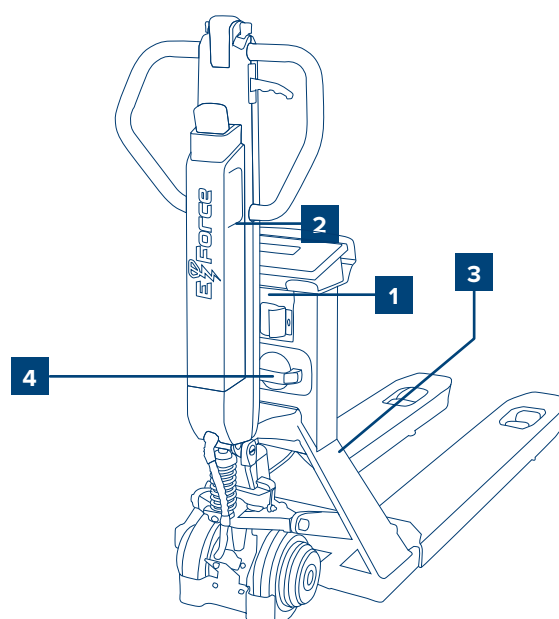

## DESCRIPTION

### Intended use (correct)

---

The machine in question is intended for **industrial use** for:

- the **weighing and handling of objects placed on Europallet**.

**Max Europallet capacity permitted:**

MODEL	CAPACITY
TPWE-FORCE	1200 kg

The machine has been designed to:

- meet the specific needs mentioned in the sales contract;
- be used according to the instructions and limits of use provided in this manual.

The machine has been designed and built to operate safely if:

- it is used within the limits stated on the contract and in this manual;
- the user manual procedures are followed;
- scheduled maintenance is carried out in the times and in the ways indicated;
- unscheduled maintenance is promptly carried out if required.

### Reasonably foreseeable misuse

---

The **reasonably foreseeable misuses**, which are to be intended as strictly forbidden, are listed below:

- transporting people;
- transporting unstable or incorrectly stacked loads or fluids;
- using the machine as a support point;
- using the machine in poorly lit areas;
- using the machine in order to obtain production values above the required limits;
- using the machine differently than described in paragraph "**Intended use (correct)**".

Any other use of the machine with respect to that required must be previously authorised in writing by the Manufacturer. In the absence of said written authorisation, the use is to be considered "**improper use**"; therefore the Manufacturer declines any responsibility in regards to damage caused to property or people and deems any type of warranty on the machine expired.



**IMPORTANT!**

An improper use of the machine relieves the Manufacturer from any responsibility.

## Obligations and prohibitions

---

### Operator obligations

The operator **must**:

- Perform maintenance operations always with the machine switched off. Not lubricate moving parts.
- When the machine is running, not operate nearby while wearing chains, bracelets, ties or other clothing that may get caught in the mechanisms.
- Operators with long hair must tie them up in order to prevent them from getting entangled.
- During operation, pay the utmost attention that no person is able to directly access moving parts.
- Use the protective devices made available by the employer in an appropriate manner.
- Immediately report any deficiencies of the safety devices to the employer, the manager or the person in charge.

### Operator prohibitions

Specifically, operators **must not**:

- use the machine improperly, i.e. for uses other than those indicated in the paragraph "**Intended use (correct)**";
- remove or modify safety or warning devices without authorisation;
- carry out operations or manoeuvres that are not within their competence or that may compromise their own safety or that of other workers on their own initiative;
- wear bracelets, rings or chains that can dangle and be dragged by moving parts, creating a hazard for the operator;
- replace or modify the speed of the components of the machine without being authorised by a manager;
- use the machine if it has not been installed according to the regulations in force;
- use the machine as a support point even if it is not running (under risk of falling and/or the risk of damaging the machine itself);
- use the machine outside the environmental conditions permitted (consult the paragraph "**Environmental conditions permitted**").



**WARNING!**

DINI ARGEO is not liable for damage to things or people if it is ascertained that the machine has been used in a non permitted environment.

## Technical data

### TPWE-FORCE

<b>Material</b>	Painted steel*.
<b>Forks dimension</b>	1150 x 550 x 87 mm.
<b>Weight</b>	121 kg
<b>Wheels</b>	2 rubber drive wheels. 4 polyurethane loading wheels.
<b>Max capacity</b>	1200 kg.
<b>IP rate</b>	-
<b>Power supply</b>	Tiller: removable rechargeable lithium-ion battery (optional fast recharge in 2 h) Weight indicator: removable rechargeable lead-acid battery.
<b>Autonomy</b>	Tiller: up to 8 h, depending on use, load and slope (3 to 5 h for standard use). Weight indicator: about 80 hours of continuous use or one month with the typical non continuous use.
<b>Recharge time</b>	Tiller: about 8 h (optional fast recharge in 2 h). Weight indicator: about 8 h.
<b>Keyboard</b>	17 keys
<b>Travel speed</b>	4,2 km/h with load / 5,3 km/h without load.
<b>Max gradeability</b>	5% with load / 10% without load.
<b>Drive motor power</b>	2x0,25 kW.
<b>Sound level</b>	70 dB.
<b>Service brake</b>	Electric.

\* Optional stainless steel forks.

## Environmental conditions permitted

---

The environment in which the machine must be used is an internal environment protected from weathering such as rain (except IP versions), hail, snow, fog, suspended dust, combustible dust and must not be classified and protected from saline solutions, aggressive agents such as acids or corrosive vapours and excessive heat sources. The ground must have an adequate maximum permitted load (cement, asphalt) and an even surface.

The machine has been designed and built to operate safely in the following environmental conditions:

Room temperature	-10°C ~ + 40°C
Maximum relative humidity	85 % non-condensing
Room lighting	min. 50 lux - non-glare light
Support surface	perfectly flat concrete industrial floor



### WARNING!

Environmental conditions other than those specified may cause serious damage to the machine and void the warranty.



### IMPORTANT!

The work surface must be sufficiently illuminated.

In the event of dark areas in the workplace, it will be the user's responsibility to provide suitable lighting devices.

## Main components

The machine is made up of the following main components:

Pos.	Component
1	LOADING FORKS
2	LOAD CELLS
3	STEERING WHEELS
4	DOUBLE LOADING WHEELS
5	ELECTRIC TRACTION TILLER
6	FIXED OR ADJUSTABLE MULTIFUNCTION WEIGHT INDICATOR
7	RECHARGEABLE BATTERY
8	BUILT-IN PRINTER

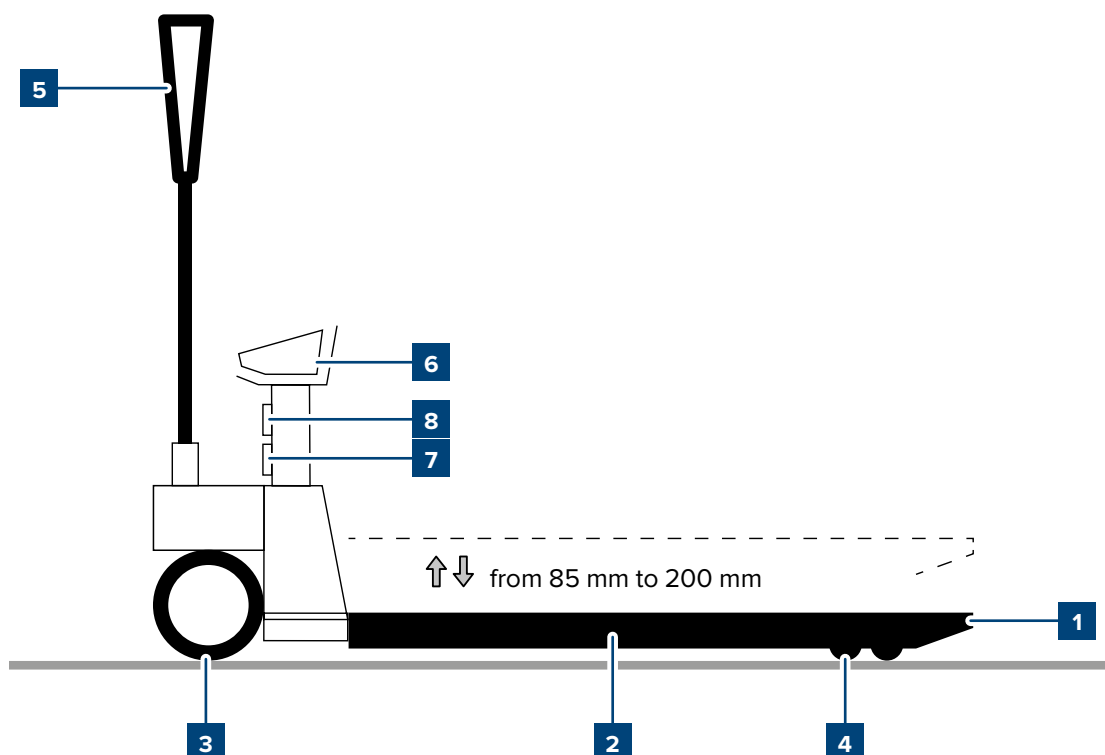



## Rechargeable battery

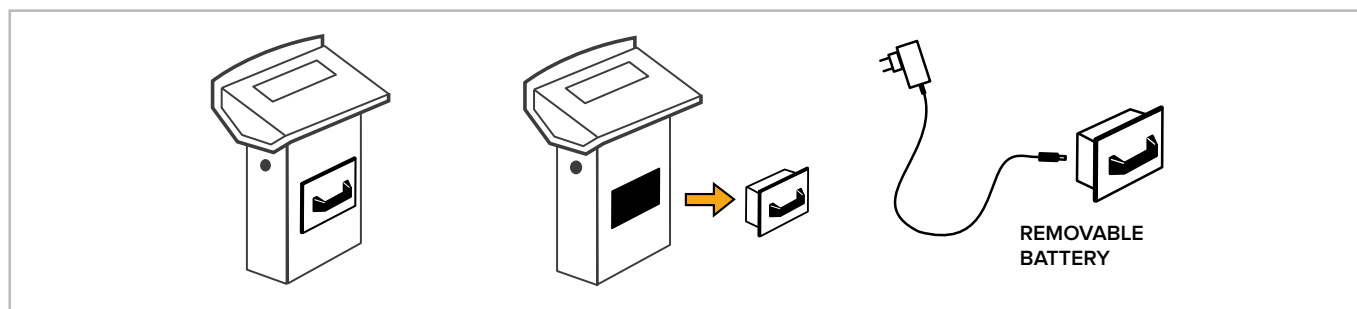

### IMPORTANT!

Before turning the pallet truck on for the first time, fully charge the battery for 12 hours.



### IMPORTANT!

Only use original batteries and battery chargers supplied.



### IMPORTANT!

During normal use, never leave the battery partially or fully discharged. Fully recharge it at least once a week.



### IMPORTANT!

In case of prolonged periods of disuse, we recommend removing the batteries (in pertaining models) and storing it in a dry place, away from changes in temperature.

## Optional components

The machine can be equipped with the following optional components:

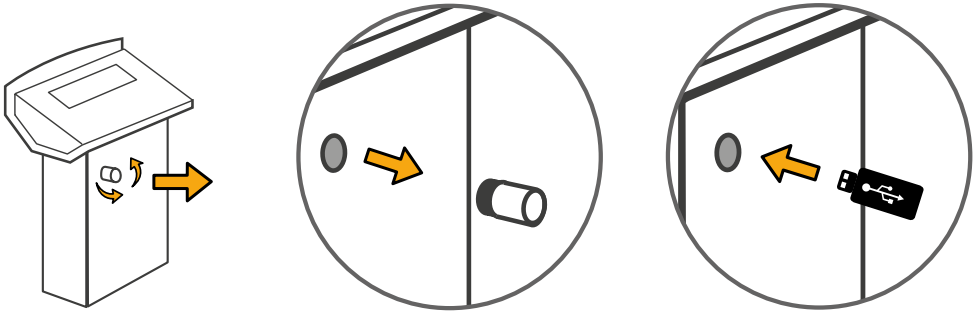
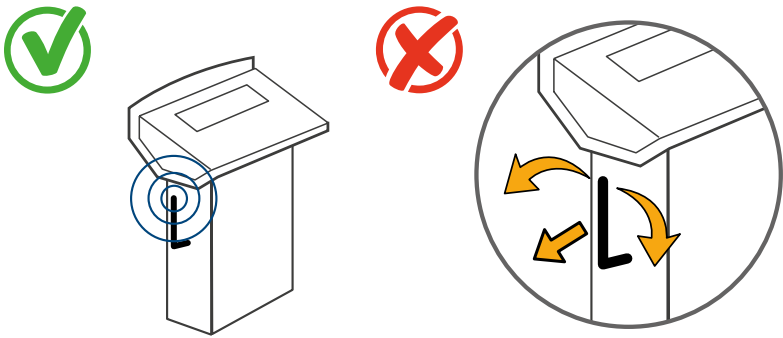
Component	Description and Image
<p><b>USB PORT</b> (depending on model)</p>	<p>Enables to store all completed weighing operations on memory stick.</p> 
<p><b>ANTENNA</b> (depending on model)</p>	<p>Fixed antenna for wireless data transmission.</p> 

# PACKAGING AND HANDLING

## Packaging and handling warnings

---



**WARNING!**

DINI ARGEO is not liable for damage, to things or people, caused by accidents due to failure to follow the instructions provided in this manual.



**WARNING!**

Use lifting equipment with a capacity suitable for the weight to be lifted.



**IMPORTANT!**

Lifting and handling operations must only be carried out by specialised and trained personnel, who are qualified to carry out these activities.

## Packaging

---

The pallet truck is transported fully assembled on a pallet and strapped to it.

Upon receiving the packaged machine, the customer must verify that there is no damage caused by the mode of transport or by the personnel in charge of the specific operations.

**If damage is detected**, leave the packaging in question in the state found and immediately request the assessment of the damage by the competent shipping company, then communicate the damage found to the competent transport insurance and sales outlet by means of a damage certificate.

## Packaging handling

The packaging must be moved by means of a forklift with a capacity suitable for the weight to be lifted (refer to the table below to check the weight of your model).

**Weights with transport crate:**

MODEL	WEIGHT
TPWE-FORCE	135 kg

For handling, proceed as follows:

1. Place the forks of the forklift under the pallet to which the TPWE-FORCE is strapped.
2. Make sure the forks come out from the rear of the load, for a length sufficient to eliminate any risk of tipping.
3. Lift slowly, making sure that the centre of gravity of the section is positioned at the centre of the lifting forks.

## Packaging disposal

The packaging is an integral part of the supply and is not collected, therefore the purchaser is in charge of disposing of it.



### **IMPORTANT!**

**Dispose of the packaging in compliance with the regulations in force in the country of the user.**

## Descent adjustment

The machine is already adjusted for correct operation. However, should it be required to perform **descent adjustment**, refer to the procedure described below:

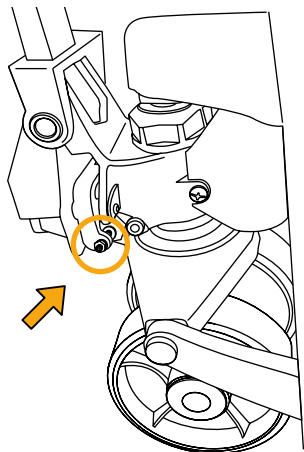

- A. Place the forks at the maximum height.
- B. Place the tiller control lever in POS. 1 (centre).
- C. Make sure the tiller is in the upright position.
- D. Unscrew the locknut, to unlock the adjustment screw.
- E. Slowly turn the adjustment screw clockwise until the forks start moving downwards.
- F. As soon as the forks start lowering, turn the adjustment screw one and a half turns anti-clockwise.
- G. Tighten the locknut, to lock the adjustment screw.
- H. Using the control lever, the downwards movement can be carried out from any tiller position.

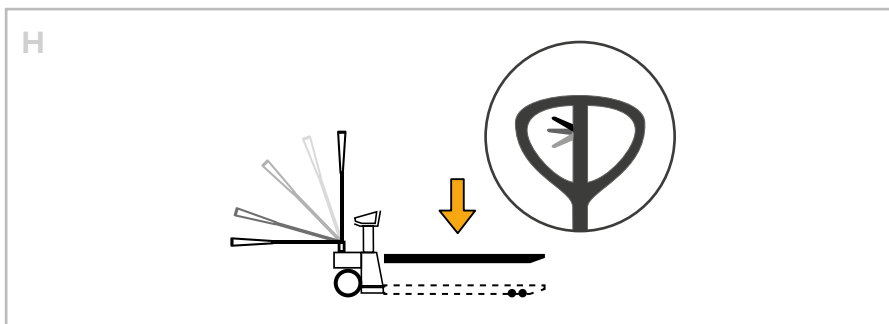
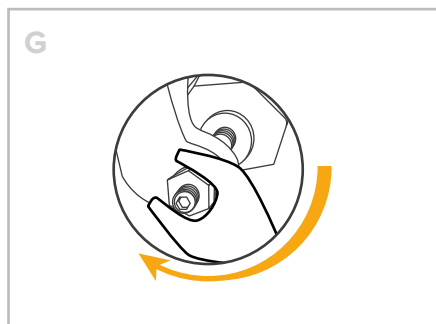
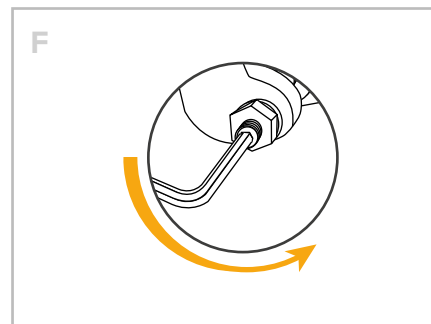
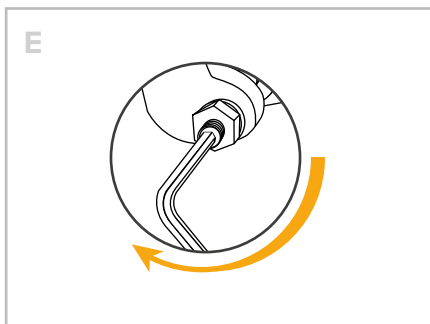
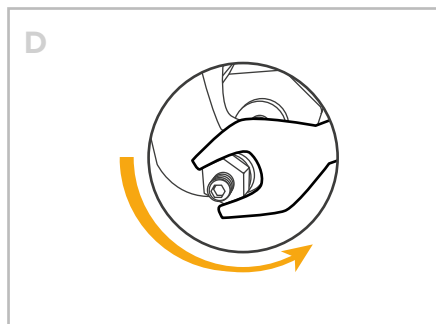
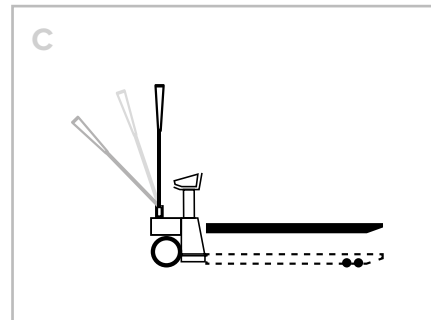
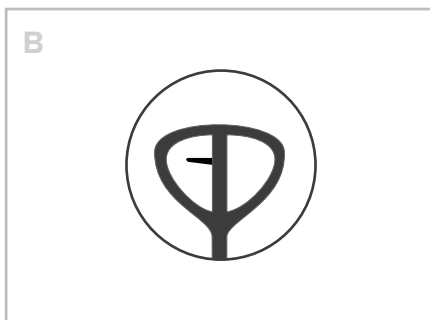
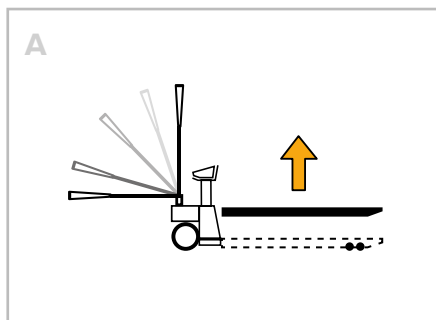

### WARNING!

Make sure that with the tiller in its transport position, it is not possible to raise the forks. Otherwise:

- release the locknut,
- turn it half a turn clockwise,
- tighten the locknut back up again.

## Tiller sensor calibration

---

1. Turn on the pallet truck and place it on a horizontal surface.
2. Activate the manual mode [press and hold of the “manual mode” button holding the tiller in the upper end stroke position].
3. Press and hold the “emergency inversion” button and at the same time press and release 4 times the “horn” button. After such sequence the horn sounds and the “Diagnostic” picture is displayed for a few moments on the display.
4. The inclinometer “SETUP” mode is active and the default parameters of the stroke sensor function are shown. The two numbers triads printed on the first two rows represents: default tiller stroke inclination limit – correction (default 0.0°) – angle span where the truck translation is not allowed starting from the end stroke inclination:
  - Row 1: “Upper limit”
  - Row 2: “Lower limit”
  - Row 3: instantaneous tiller inclination
  - Row 4: traction board inclination
  - Row 5: correction acquisition confirmation.
5. UPPER CORRECTION SETTING: keeping the tiller on the upper stroke limit press and hold the “horn” button. When the “horn” button is pressed, the horn emits a short acoustic signal; subsequently, after a short silence break, the horn emits a longer tone at the end of which the “horn” button can be released. While the second signal is emitted the led underneath the “horn” button turns on at → the upper angle correction has been acquired and the second value of the first triad becomes different than 0.
6. LOWER CORRECTION SETTING: place the tiller on the lower limit, press and hold the “horn” button. When the horn button is pressed, the horn emits a short acoustic signal; subsequently, after a short silence break, the horn emits a longer tone at the end of which the horn button can be released. While the second signal is emitted the led underneath the central button turns on → the lower angle correction has been acquired and the second value of the second triad becomes different than 0.
7. Record the corrective parameters holding the “horn” button until a sound signal is produced and the system leaves the SETUP menu.
8. CALIBRATION EFFECTIVENESS VERIFICATION: lift the forks in order to place the major rocker arm side in a horizontal position, then rotate the tiller and verify if the led light underneath the “horn” button turns on after a rotation of about 10 degrees. Continue rotating the tiller until the led light turns off (the lower traction disabling position is reached). Verify that the led light turns off some degrees before the lower stroke mechanical limit. In case this condition is not satisfied, repeat the calibration procedure.

Warning: hold the tiller on the upper and lower limit positions applying a gentle push. An excessive pushing may cause a wrong acquisition of the correction parameters.

Warning: in order to prevent errors, in case the correction acquired is not coherent with the expected values, the systems resets to zero the calibration. This control feature can be also used to reset the correction values to zero, performing a calibration procedure that acquires two inconsistent values (for example two equal values or a central value).

# COMMANDS

## Tiller commands

The raised load is moved forwards or backwards by the tiller, which controls the steering wheels. The tiller can be used in the following conditions:

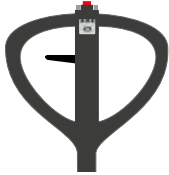
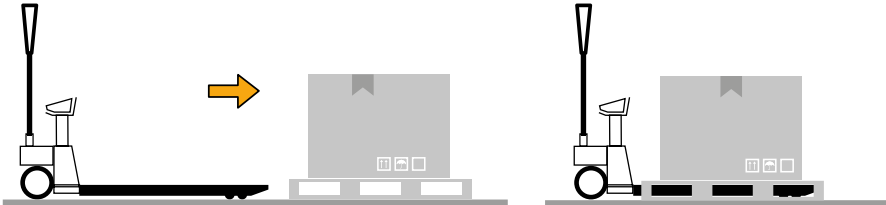
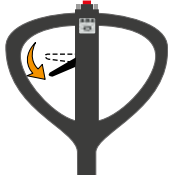
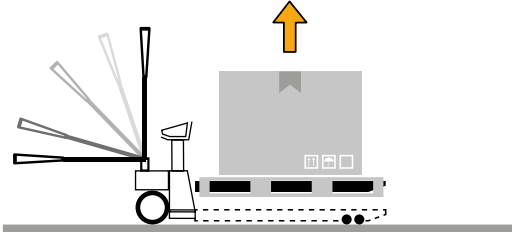
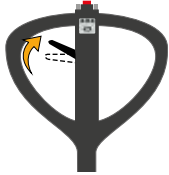
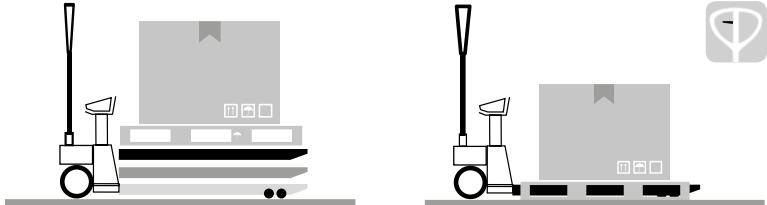
Condition	Image	Mode
AT THE CENTRE		<p><b>TRANSPORT</b></p> <p>The tiller is completely free for transport manoeuvres.</p> 
DOWN		<p><b>LIFTING</b></p> <p>Pull the tiller downwards to start up the lifting pump. A return spring places the tiller back in its upright position.</p> 
UP		<p><b>DESCENT</b></p> <p>Pull the lever upwards to lower the load. The descent speed is controlled by a special valve that starts up when the lever is firmly pulled to the end of its stroke.</p> 

 **IMPORTANT!**  
 The pallet truck is equipped with a dual-function tiller: traction or manoeuvre and hydraulic lift. Raise or lower the truck only when stationary.

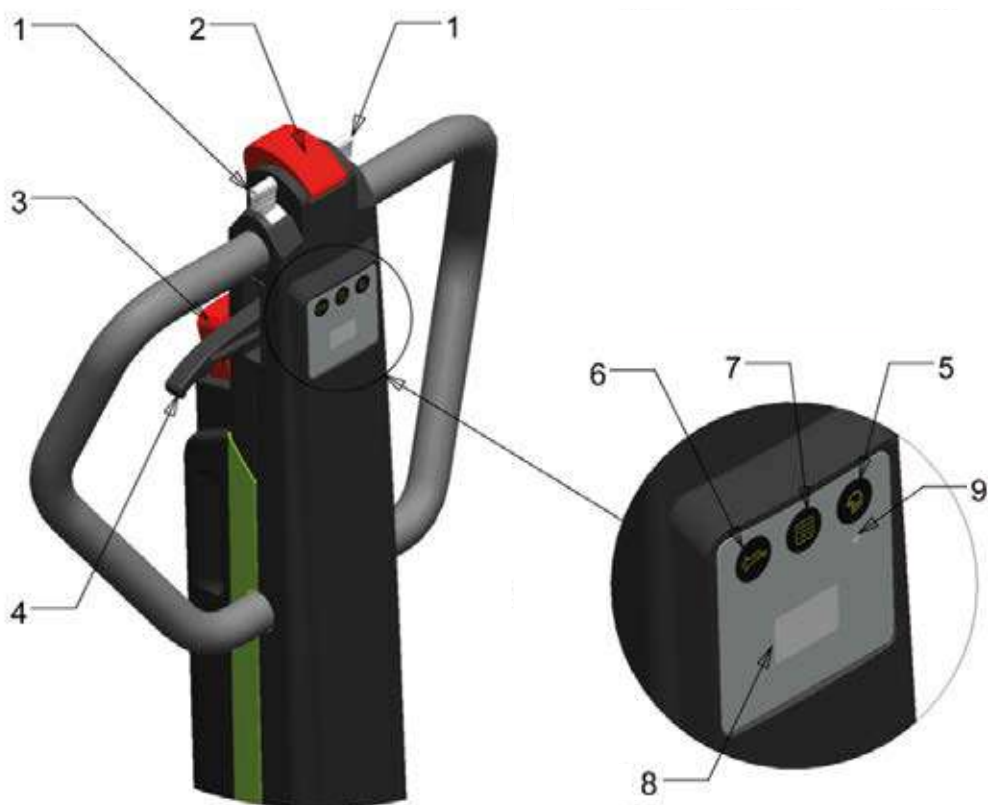

Pos.	Description
1	Accelerator
2	Emergency reversal button
3	Ignition key
4	Control lever
5	Manual mode button
6	Horn button
7	Display screen selector button
8	Display
9	Manual mode LED



## Tiller display

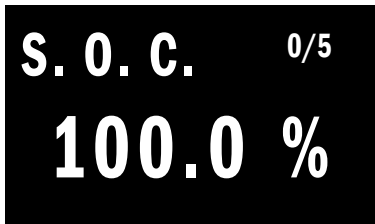

Page 0

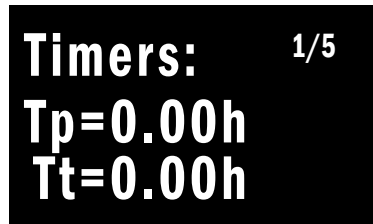

Page 1

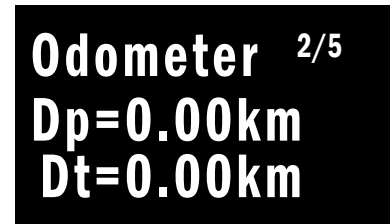

Page 2



Page 3

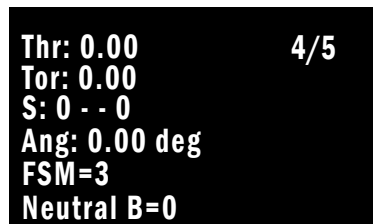

Page 4

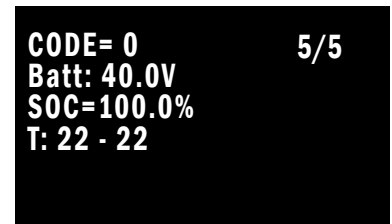

Page 5

### Page 0 - Battery

Shows the battery charge level, reported as a “%” value with respect to the maximum capacity.

### Page 1 - Times

It shows the following parameters: “Tt”, which indicates the total time in electrical mode of the machine since the first ignition; “Tp”, which indicates the translation time in electric mode since the last reset. To reset the “Tp” parameter, when on Page 1, keep the SCREEN SELECTOR button pressed until the parameter is reset.

### Page 2 - Distance traveled

The parameters “Dt” and “Dp” respectively indicate the total distance traveled by the machine in electric mode from the first start up and from the last reset. The “Trip (km)” parameter can be reset starting from Page 2 with the same procedure used for resetting the “Tp” parameter. Please note: The reset of the “Tp” parameter also involves that of the “Dp” parameter and vice versa.

### Page 3 - Speed adjustment

In this page, it is possible to select the operating mode of the motor, adjusting the maximum translation speed of the forklift. The “Speed Set” parameter represents the value of the maximum speed set on the forklift expressed as % of the maximum possible speed. The parameter default setting is 100%. On this screen, each time the acoustic signal button is pressed, the speed can be changed in the sequence 100% -60% -70% -80% -90% -100%. The page also shows the real time translation speed of the forklift, shown in km/h.

### Page 4 - Diagnostics

It provides indications on the operating status of the electronic control of the motors, reporting the following parameters: “Thr”, variable from 0 to 100, represents the % of accelerator actuation; “Tor”, which indicates the traction torque applied by the wheels; “S”, made up of two values that respectively represents the right motor and the left motor speed; “Ang”, which represents the angle (in degrees) of orientation of the bar with respect to the vertical position; “FSM”, which is associated with a two-digit number representing the logical state of electronic traction control and is useful for identifying any problems in the event of operating anomalies; “Neutral”, it indicates that the throttle is in stand-by position. The indication changes to “Forward” when the throttle is rotated to obtain the forward translation or to “Backward” when it is rotated to obtain the backward translation; “B=0”, shows the status of the emergency inversion button, b=0 if button is not pushed, B=1 if button is pushed.

### Page 5 - Errors

It shows the “CODE” parameters whose number represents a certain error code; “Batt”, show the battery voltage; “SOC”, shows the battery charge level, reported as a “%” value with respect to the maximum capacity; “T”, made up of two values that respectively represent the temperature of the right motor and left motor control driver.



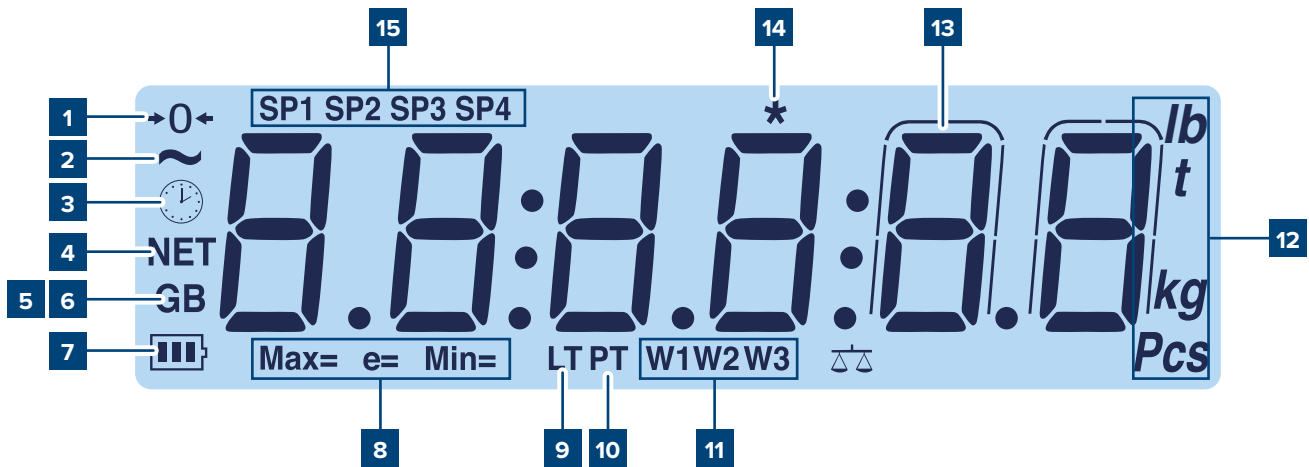





## Weight indicator display



Pos.	Icon	Description
1	→0←	Indicates that the scale is unloaded and at zero (gross).
2	~	Indicates that the weight is unstable.
3	🕒	Displays the time.
4	NET	The net weight is displayed. <b>Note:</b> there is a saved tare.
5 / 6	G B	The gross weight is displayed.
7	🔋	Indicates the battery level: 
8	Max= Min= e=	Metrics are displayed.
9	LT	A locked tare is active.
10	PT	A manual tare is active.
11	W1 W2 W3	Indicate the range of active weighing.
12	lb ... Pcs	Indicates the units of measurement: pounds (lb), tonnes (t), kilograms (kg), grams (g), number of pieces (pcs).
13	📏	The weight is displayed in high resolution.
14	*	This means a key is pressed. In some operating modes, it means that a specific function is active.
15	SP1... SP4	These indicate the active relay outputs (only with the optional board).

## Keyboard types



Button	Description
	<ul style="list-style-type: none"> <li>Resets the weight on the scale.</li> <li>If pressed for a long time (2 sec), it is possible to set the brightness of the display.</li> </ul>
	<ul style="list-style-type: none"> <li>Performs tare on the scale.</li> <li>If pressed for a long time (2 sec), a preset tare can be entered.</li> </ul>
	<ul style="list-style-type: none"> <li>Recalls the specific function of the operating mode.</li> <li>If pressed for a long time (5 sec), it allows to change the operating mode.</li> </ul>
 	<ul style="list-style-type: none"> <li>Confirm key.</li> <li>Prints the receipt.</li> <li>If pressed for a long time (5 sec), the configuration menu can be accessed.</li> </ul>
	<ul style="list-style-type: none"> <li>If pressed for 2 sec it switches off the instrument.</li> <li>If pressed for 5 sec it displays the metrological information.</li> </ul>
	If pressed for a long time (2 sec) it displays the metrological information.
	Performs the function (followed by pressing a number).
	If on, it indicates that the instrument is charging (for battery powered instruments).



It allows to quickly set a numerical value.



**WARNING!**

For a clearer view and advanced functions related to the keys and operating modes, see the chapter “BASIC SCALE FUNCTIONS” and “ADVANCED SCALE FUNCTIONS”.

# USE

## General warnings for correct weighing

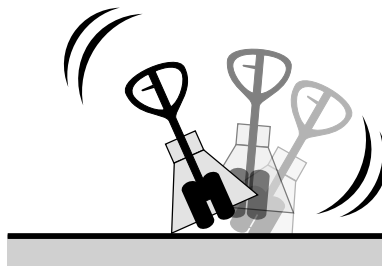
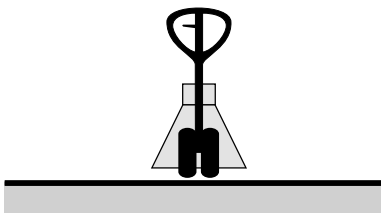
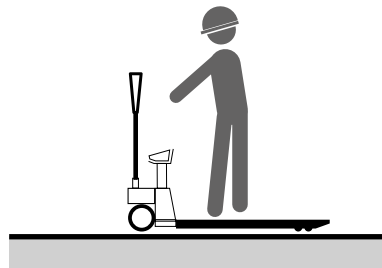
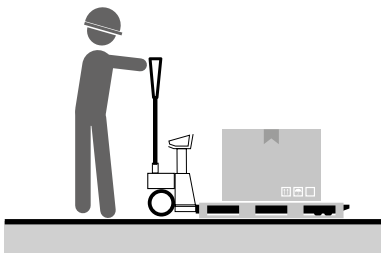
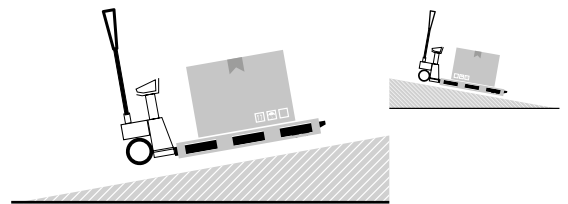
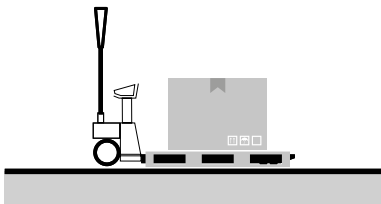

**WARNING!**  
Pay attention during manoeuvring operations as the tiller has an upright return system.

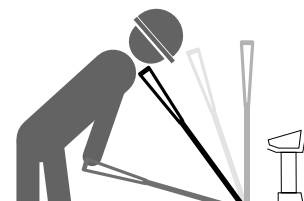

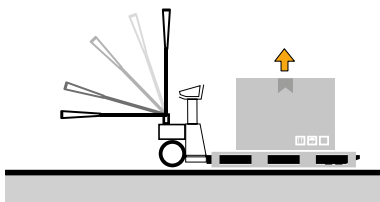
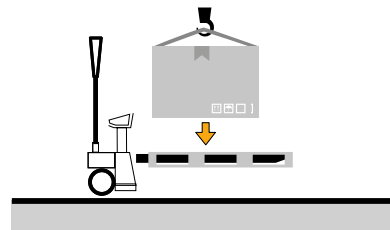
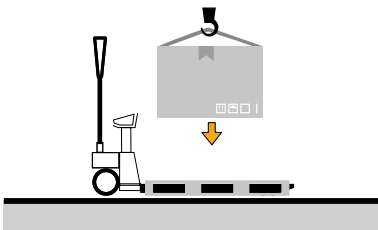
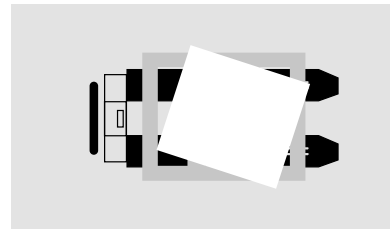
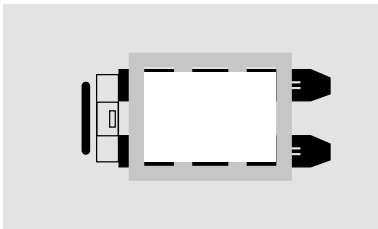
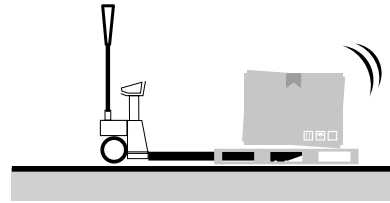
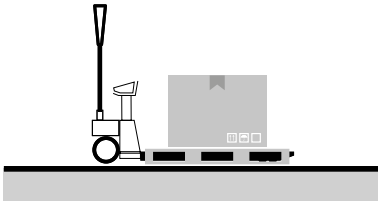

ONLY LIFT FROM STATIONARY\*

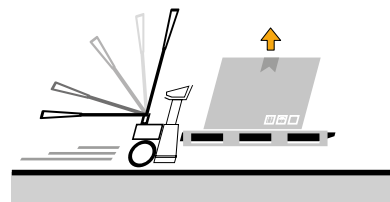

**IMPORTANT!**

The pallet truck is equipped with a dual-function tiller: traction or manoeuvre and hydraulic lift.

Note: raise or lower the truck **ONLY** when stationary.

## Safety standards

### DANGER

The truck must be used in accordance with the following standards:

- The operator must be properly trained, know the instructions for use relating to the vehicle and wear the appropriate personal protective equipment.
- The operator, responsible for the forklift, must prevent untrained persons from driving the vehicle and prevent anyone from getting on the forks.
- During driving, the operator must appropriately reduce the speed when cornering, in narrow passages, going through doors or on uneven floors. He/she must make any unauthorized person move away from the area where the forklift operates and immediately inform if there are people in danger; in the event that, despite the warning, there is still someone in the work area, the operator must immediately stop the forklift.
- It is forbidden to stand near the moving parts of the forklift and climb onto the fixed parts of the forklift.
- The operator must avoid sudden braking and fast reversing.
- The maximum slope for the forklift is indicated in the technical sheet. Never exceed the indicated limits. Never drive the truck across the slope. Ascents and descents are to be followed always and solely in the electric mode, in both loaded and empty conditions, with the forks facing upstream and with the lifting system lowered to a minimum height that allows translation.
- During driving, the operator must be careful to have good visibility and have free space when reversing.
- If the truck is transported on elevators, it must enter with the loading forks to the front. Never enter an elevator without prior authorization from the supervisor. Check the elevator capacity (it must support the weight of the forklift plus the operator plus any load). Approach the elevator slowly. Operate the elevator only after the forklift is well centered and perfectly level so that the elevator is well balanced. Make sure that the forks or other parts of the truck do not exceed the shape of the elevator.
- It is absolutely forbidden to take out of service or disassemble the safety devices.
- The lifting capacity of the forklift cannot be exceeded under any circumstances. The driver must make sure that the load is well placed on the forks and in perfect order; never protrude beyond the ends of these more than 50 mm.
- Before starting the work, the driver of the forklift is required to carry out the preventive checks indicated (see the following paragraph PREVENTIVE CHECKS).
- The forklift must always be used or parked away from rain and snow and in any case must not be used in very humid areas.
- The forklift must be used only indoors, in suitable areas and in normal environmental conditions. Permitted environmental conditions:
  - Temperature: 0 °C ÷ 40 °C
  - Altitude: up to 2000 meters
  - Relative humidity: 30 ÷ 95% (without condensation)
  - Minimum required lighting: 40 lux.
- In the presence of facilities with environmental conditions that are critical due to temperature, humidity or aggressiveness (salinity, dustiness, etc.), consult your dealer. If the truck works for long periods at altitudes above 1000 m, it is necessary to take into account that the cooling of the motors will be less efficient compared to working conditions at sea level.
- Immediately report any damage, breakdown or malfunction to the responsible personnel. If the forklift needs repairs, place a clearly visible sign with the wording “OUT OF ORDER - DO NOT USE” and remove the key from the battery.
- It is forbidden to use the forklift until it is repaired.
- If the driver does not have the necessary qualification, he/she is not authorized to carry out repairs on the forklift and is not allowed to deactivate or modify the safety devices and switches.



The manufacturer does not accept any charge related to failures or accidents due to negligence, incompetence, installation by non-authorized technicians and improper use of the forklift.

## Preventive checks

### PREVENTIVE CHECKS WITH THE FORKLIFT SWITCHED OFF



#### WARNING

Before using the forklift, check the conditions of the following parts as described in chapter MAINTENANCE:

- Check the condition of the forks.
- Check the condition of the linkage and the correct operation of the manual control lever in the three positions (neutral, lifting, lowering).
- Check the condition and wear of the wheels and rollers.
- Check for oil leaks from the hydraulic unit.
- Check for damage to the battery.
- Check the effectiveness of the driving bar return mechanism, making sure that when taking it to low position it returns automatically to a vertical position
- Check the condition of the safety labels and stickers.

### PREVENTIVE CHECKS WITH THE FORKLIFT TURNED ON



#### DANGER

Before using the forklift, check the operation of the following parts as described in chapter OPERATING PROCEDURES:

- Check that with the driving bar in the upper position and in the lower position the translation is not possible by actuating the accelerator.
- Check that with the driving bar in the working position the translation works correctly by actuating the accelerator.
- Check the operation of the emergency reversal button.
- Check the operation of the brakes.
- Check the operation of the horn.
- Check the operation of the manual mode.
- Check the operation of the turtle mode.



#### DANGER

Do not enter with the forklift in places where flammable gases, vapors or dusts develop. The forklift is not equipped with explosion-proof guards.



#### WARNING

Take the utmost care WHEN transporting hazardous materials; flammable liquids, acids, etc. must be transported in special closed containers. Avoid routes with holes, bumps and obstacles; if impossible, evaluate from time to time if they can be crossed and drive the forklift with extreme caution. Arrange so that holes, bumps and obstacles are removed as much as possible.



## CAUTION

IMPROPER USE ON NON-SUITABLE SURFACES MAY CAUSE DANGEROUS SITUATIONS AND REDUCE THE LIFE OF THE FORKLIFT. Contact the service network for advice on the arrangement of the surfaces or the type of forklift most suitable for the surface in question.

## Route

---

## WARNING

Remove loose materials from the area of use that could cause the wheels of the forklift to slip or otherwise interfere with the use of the forklift. Never enter wagons or trailers without first checking that their wheels are braked or blocked with wedges. Check the tightness and condition of the flooring. Check the width, capacity and reliability of the loading surfaces. Observe the route. Check that the passage area is free. Pay attention to obstacles and the surrounding space, especially at the top. The danger points along corridors or paths must be secured and equipped with the usual road signs and, if necessary, additional signs.

## Parking

---

## CAUTION

Before parking, lower the load completely. If leaving the forklift, turn it off. If the operator leaves the sight of the forklift, he/she must hold the keys in order to prevent others from using the machine. Avoid parking on a slope. In parking stops, even short ones, if possible do not stop the forklift on slopes.

## Towing or pushing

---

## CAUTION

Forklifts should not be used to push or tow loads or people.

## Change of direction

---

## DANGER

A forklift can also be tilted at low speed due to the center of gravity of the load. A dangerous curve taken at relatively high speed can lead to the truck overturning. The truck is less stable when the forks are raised, even without load. A non-centered load on the forks and uneven paths increase the risk of tipping over. In taking a curve, the operator must take into account the displacements of the forklift due the change of direction. The operator must take into account the stowage aisle, always making sure that the space in which the curve takes place is free

from obstacles. Not taking into account the stowage aisle corridor when facing a curve can also cause serious accidents. To eliminate the risk of overturning, never turn on a slope.

## Handling of loads

---



The indication of the maximum capacity on the plate relates to the maximum weight that can be raised at the related height and center of gravity. Factors such as the poor consistency of the pavement, rough terrain or loads with a high center of gravity that reduce stability must be taken into consideration; to work safely, the actual load capacity in these cases must be less than the maximum allowed.

## Load stability

---



Work only with stable loads. Never load unstable items. Do not handle a load composed of several detached parts if one of these parts is in precarious balance and close to falling. The transport of oscillating loads is not permitted.

## Load positioning

---

Make sure that the weight of the load is well distributed and balanced on the forks so that the load does not unbalance when taking a curve.



An unbalanced load on the forks will increase the risk of overturning.

## Operations with the load

---

### TRANSLATION WITH THE LOAD



Avoid sudden departures and movements that can lead to the overturning of the load with consequent damage or injury to property or persons.

## Operations without the load

---

### TRANSLATION WITHOUT THE LOAD

Never drive the empty machine with the forks in raised position. Move with the forks raised only as far as it will allow them not to touch the ground and avoid obstacles.

## Driving rules

---

### VISIBILITY

In order to define the concept of visibility, it is necessary to indicate the terminology used for travel directions. The forklift in question is a machine that can only be driven by an operator on the ground. In general, the forward direction of the forklift is that which gives the best visibility to the operator.



Should the truck travel in poor visibility conditions, the operator must be assisted by specialized and authorized personnel.

### SPEED

The speed of travel of the forklift must be commensurate with the possible presence of people in the work area of the machine itself and with visibility, pavement status and load. Particular attention should be given to driving on wet and slippery routes. In any case, the truck must be driven at such a speed that it can be stopped safely.

### PEDESTRIANS

Use the horn to warn of the presence of the forklift and the danger that could arise for exposed persons such as pedestrians and people on the forklift path. Slow down near intersections, ramps and blind curves in order to reduce collision possibilities.

### GROUND OBSTACLES

Avoid potholes, bumps, puddles and scattered objects that could cause skidding or overturning. Always choose the easiest route for the forklift.

### MANEUVERING SPACE

Always pay attention to the space required for maneuvers, with particular attention to the forks, and to the stowage aisle. The operator must always keep in mind that the forks can protrude beyond the load, so they could accidentally bump on or lift other materials.

### NARROW PASSAGES

Any narrow passages must be specially marked. Before entering a narrow passage, the driver must check that there are no people or other forklifts in the aisle. In this case, or if there are not enough measures to protect people or to avoid collisions with other trucks, the driver is prohibited from entering the passage.

### CAUTION

Always drive the forklift with extreme caution: to avoid skids, jolts, etc. Carefully avoid creating dangerous situations, such as speed competitions and stunts.

### OVERTAKING

Never overtake other forklifts near intersections, blind spots and other dangerous locations.

## ROAD EDGES



Always keep at a safe distance from the ends of risky routes such as platforms, docks and ramps. Always pay attention to waste.

Always bear in mind that when steering to move away from the ends of a loading surface, the forklift will make a sudden movement in the direction of the end itself.

## CONNECTING RAMPS

Before driving on connecting ramps, the operator must make sure that the ramp has been correctly assembled and secured and that its transport capacity is adequate. On connecting ramps, proceed only at reduced speed and with extreme caution. The operator must make sure that the vehicle on which the loading and unloading operations are to take place does not move and that is able to support the weight of the forklift, the load and the operator.

## BRAKING DISTANCE

In all driving conditions, the forklift must be driven at a speed that makes it possible to safely stop it in any situation, even when there is a sudden obstacle. Keep in mind that the braking spaces increase with the truck loaded and with smooth or wet floors.

## FORKLIFT ARREST

The arrest must always take place as gradually as possible. Sudden braking and skidding can cause the load to fall.

## FORKLIFT PARKING

The operator must never leave the truck in conditions that could cause damage or injury. To park the truck, follow these instructions:

- stop the truck
- lower the forks completely
- turn off the forklift

When the butterflies are released in the neutral position, the parking brake is automatically applied to the driving wheels. Do not park on ramps or slopes. Remove the key from the battery.



Never park the truck in such a way as to prevent access to emergency exits, stairs and fire-fighting equipment.



Never park the forklift in a cold room.



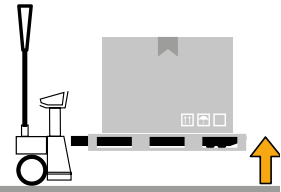
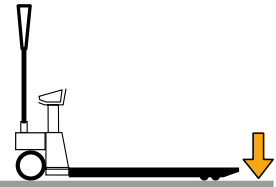
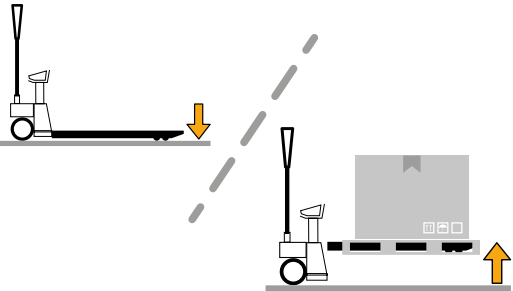

## Pallet truck conditions

Condition	Description
 A line drawing of a pallet truck carrying a grey rectangular load. The forks are raised vertically. An orange arrow points upwards from the ground level to the bottom of the forks.	The pallet truck is on, loaded and the forks are raised from the ground.
 A line drawing of a pallet truck with a grey rectangular load. The forks are lowered to the ground level. An orange arrow points downwards from the top of the forks to the ground.	The pallet truck is on, loaded and the forks in lowered position.
 A line drawing showing two pallet truck configurations separated by a dashed diagonal line. On the left, the truck has lowered forks with a downward-pointing orange arrow. On the right, the truck has raised forks with an upward-pointing orange arrow.	In this condition it does not matter whether the pallet truck is loading or unloading.

## Display switch-on

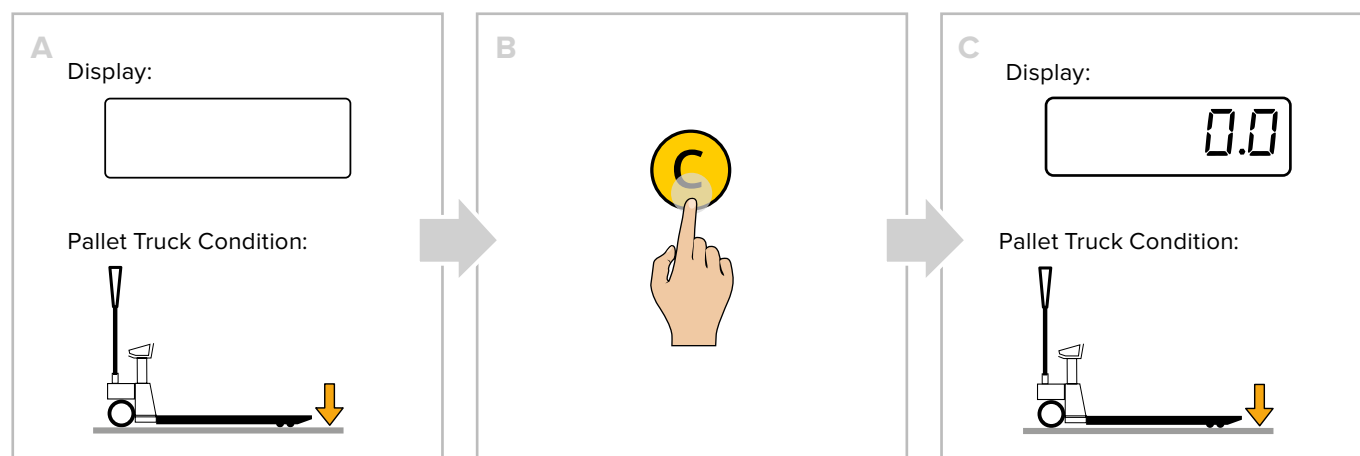
**IMPORTANT!**

Unload the Pallet Truck before turning it on

**IMPORTANT!**

If the instrument is approved, the power on must be carried out on the surface where the weighing will take place.



## Pallet truck positioning

Position the pallet truck under the load to be weighed, as shown in the figure below.



### IMPORTANT!

With approved scale, you can perform weighing on EUR pallet 800 x 1200 mm (UIC standards 435-2 and UIC 435-4 ref.).

## Load lifting and weight reading

Lift the load, as shown in the figure below.

The value of the weighing can be read on the display.

Weighing accuracy is achieved when the pallet truck is fully stationary.

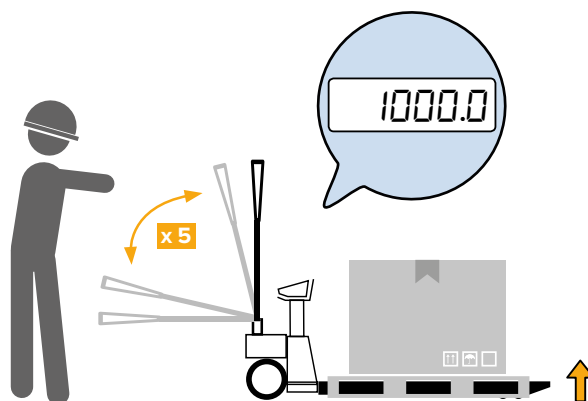

### WARNING!

Make sure the pallet is fully raised from the ground.

## How to replace the roll

To replace the integrated thermal printer roll (if present), proceed as follows:

- A. Open the door by pressing the centre button.
- B. Put the roll in, keeping the thermal surface facing outward.
- C. Close the door by pressing on both sides.
- D. Remove excess paper.

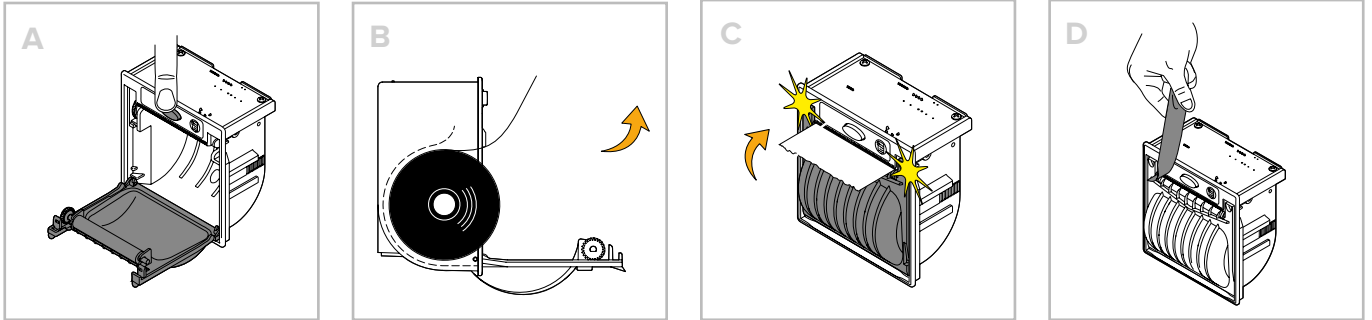

## Customisable printouts

If the instrument is equipped with a printer, the ticket or label can be customised as shown in the following example.

 Customising printouts requires advanced configuration.

### Example of ticket/label

MARIO ROSSI SRL VIA DELL'INDUSTRIA, 20 41042 - FIORANO (MO) - ITALY WWW.MARIOROSSI.IT	Header
WEIGHING NUM. 1	Progressive weighing number (for accumulation modes)
GROSS 15,000 kg TARE 3,000 kg NET 12,000 kg	Weight data
TICKET No. 54321	Progressive ticket number
05/08/2015 15:39:03	Date and time
	Bar code 39

### Example of packing list

MARIO ROSSI SRL VIA DELL'INDUSTRIA, 20 41042 - FIORANO (MO) - ITALY WWW.MARIOROSSI.IT
WEIGHING NUM. 00000001 NET 1,000 kg
WEIGHING NUM. 00000002 NET 1,000 kg
WEIGHING NUM: 00000003 NET 1,000 kg
WEIGHING NUM. 00000004 NET 1,000 kg
TOTAL WEIGHINGS 00000004 TOTAL NET 4,000 kg TICKET No. 12345 09/05/06 15:39:03

# BASIC SCALE FUNCTIONS

## Start-up - On

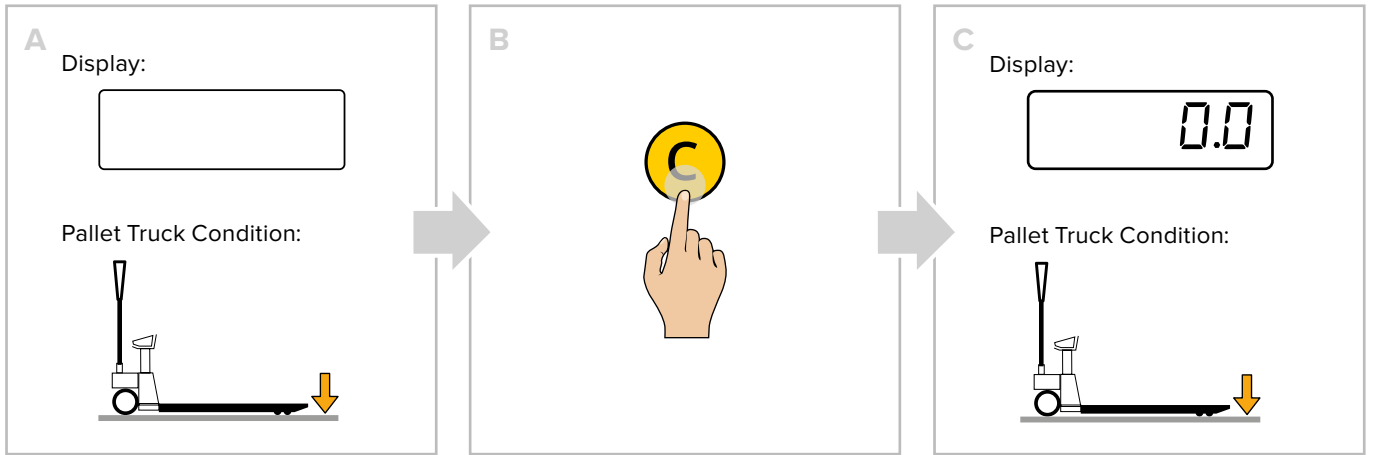

## Shutdown - Off

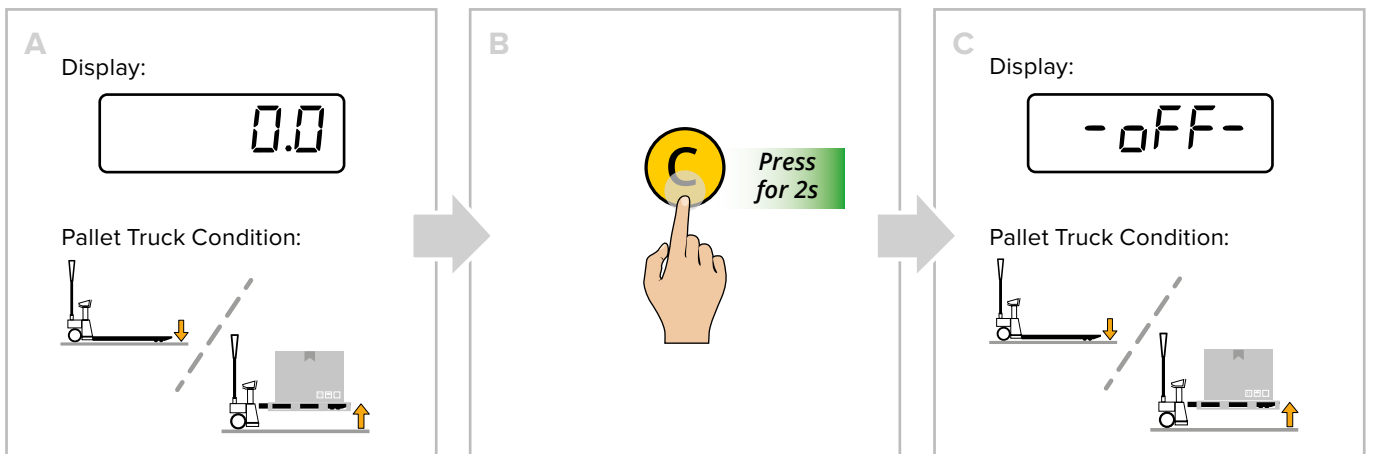

## Zero

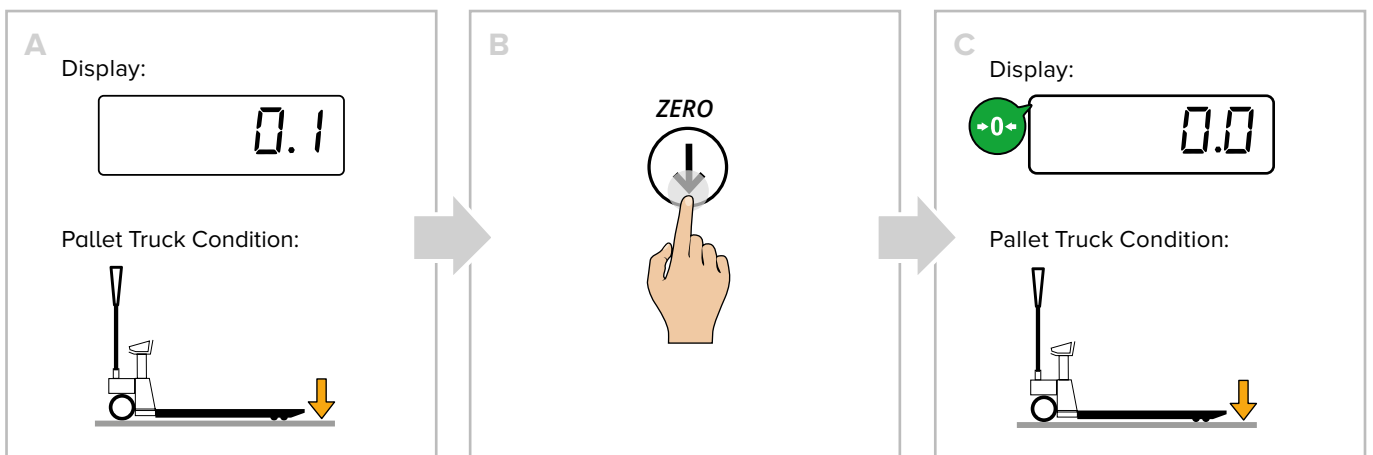

## Display brightness adjustment

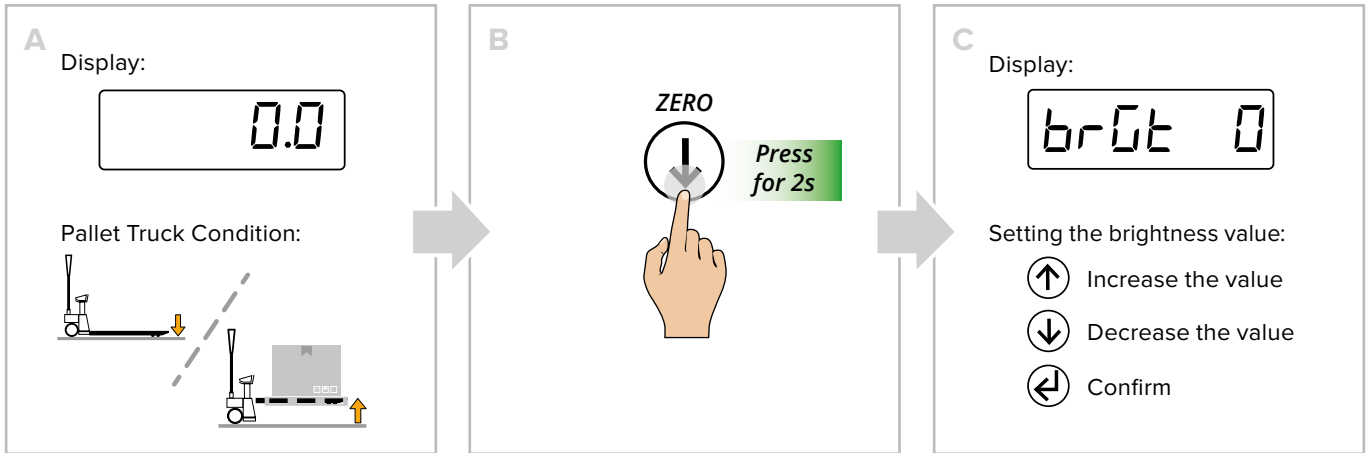

## Automatic tare

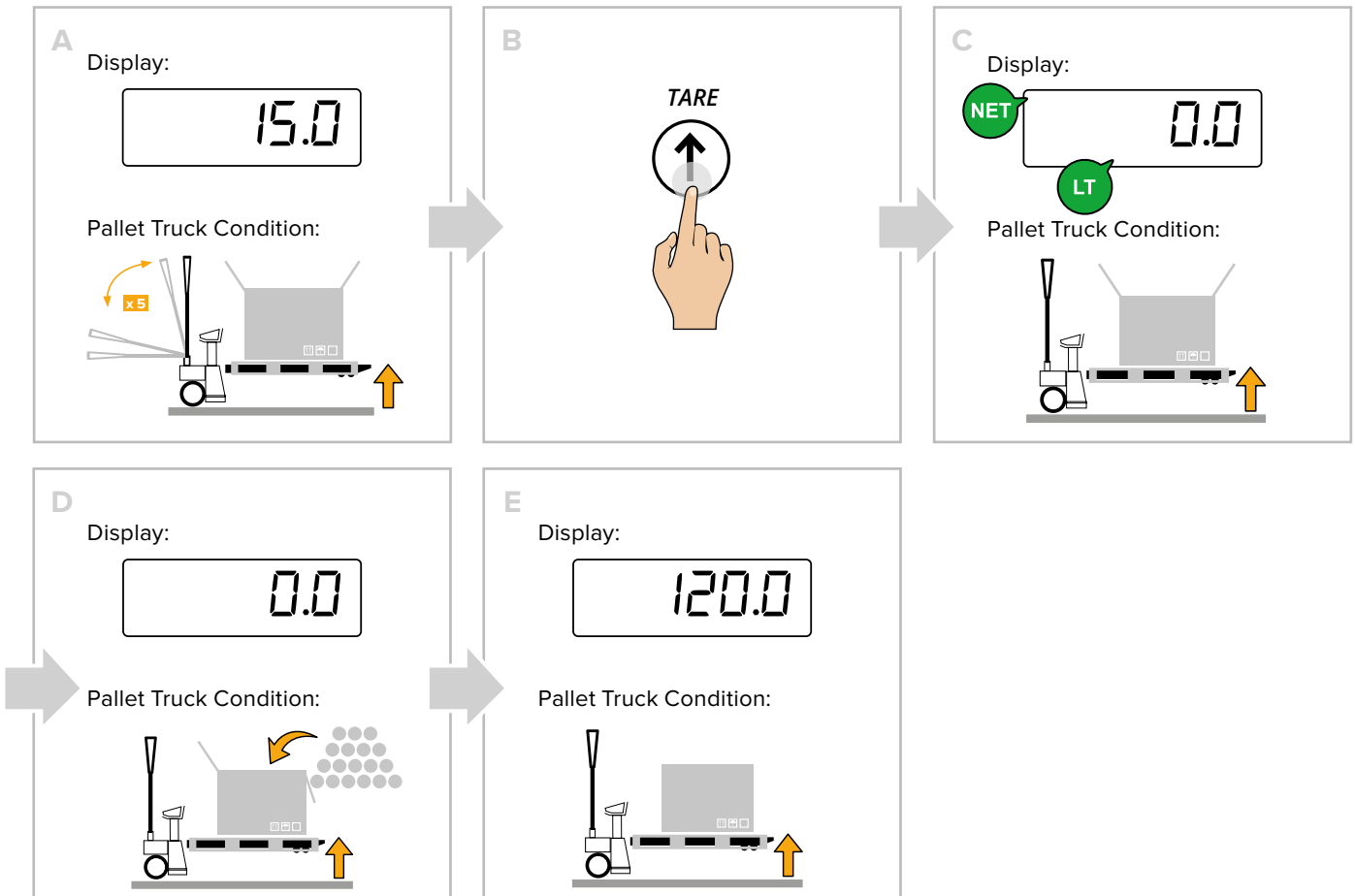

## Tare deletion

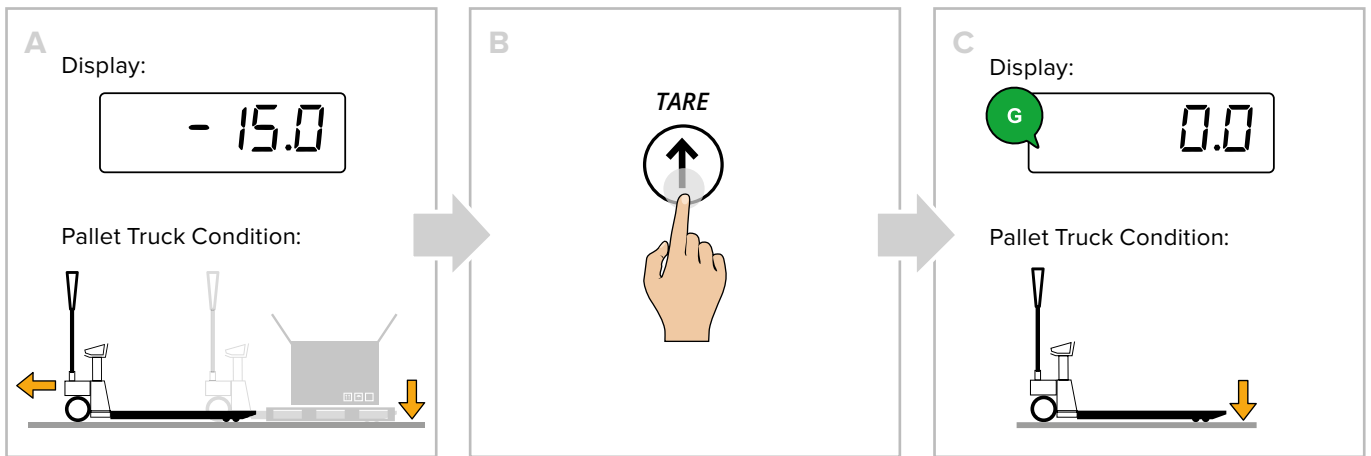

## Set a known tare value (PT)

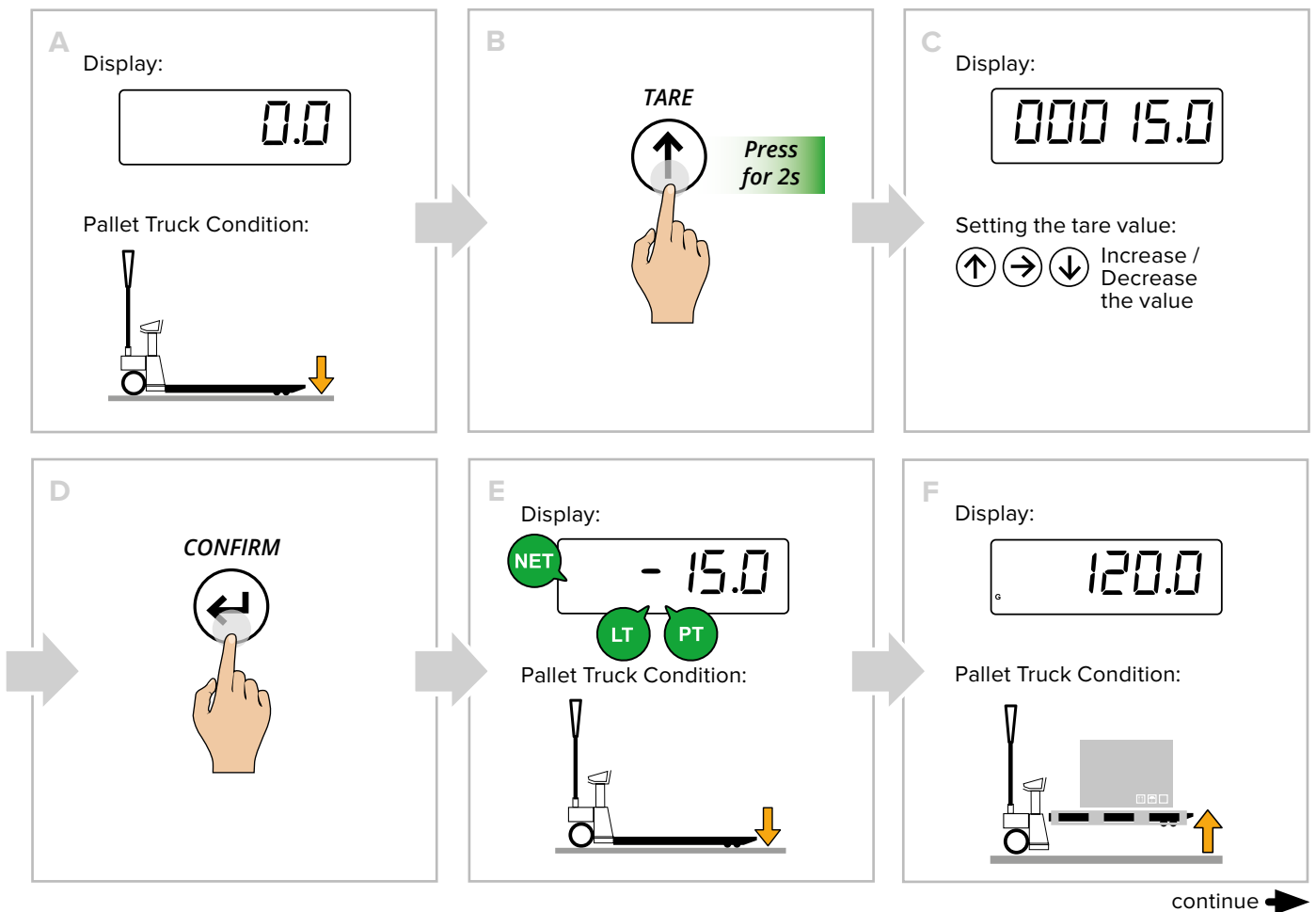
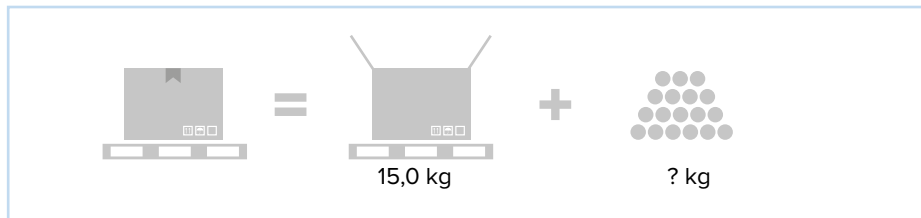

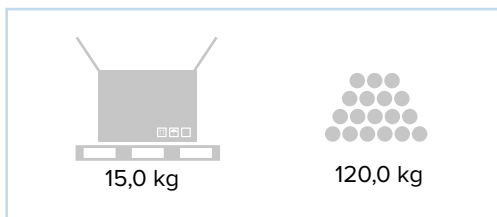

If the pallet truck has a number keypad, it is possible to enter the tare quickly:

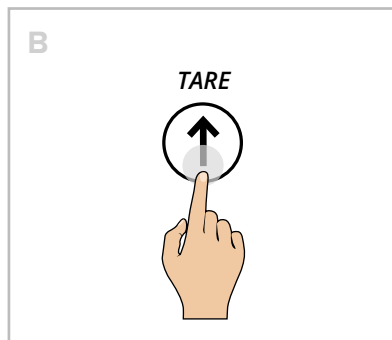
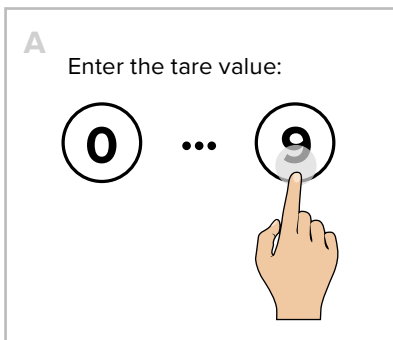

## Print

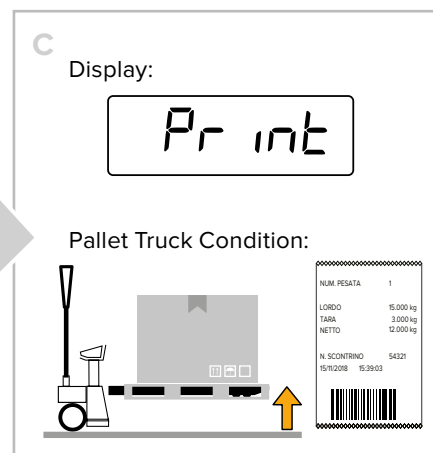
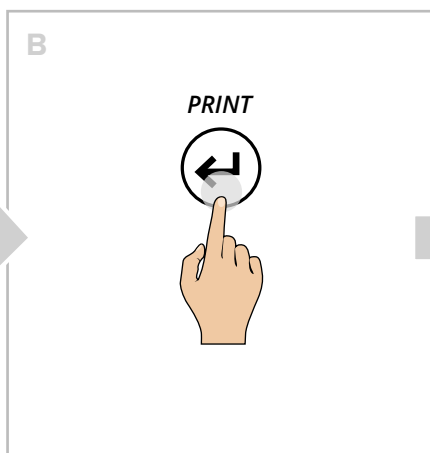
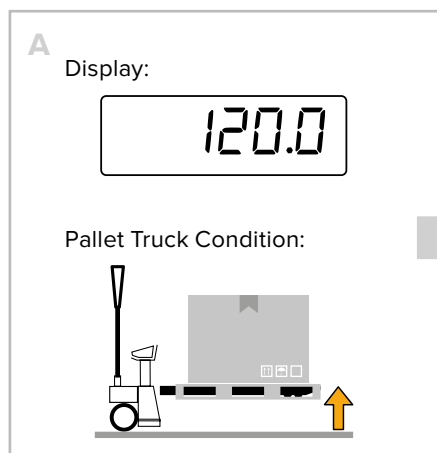

## Metrics

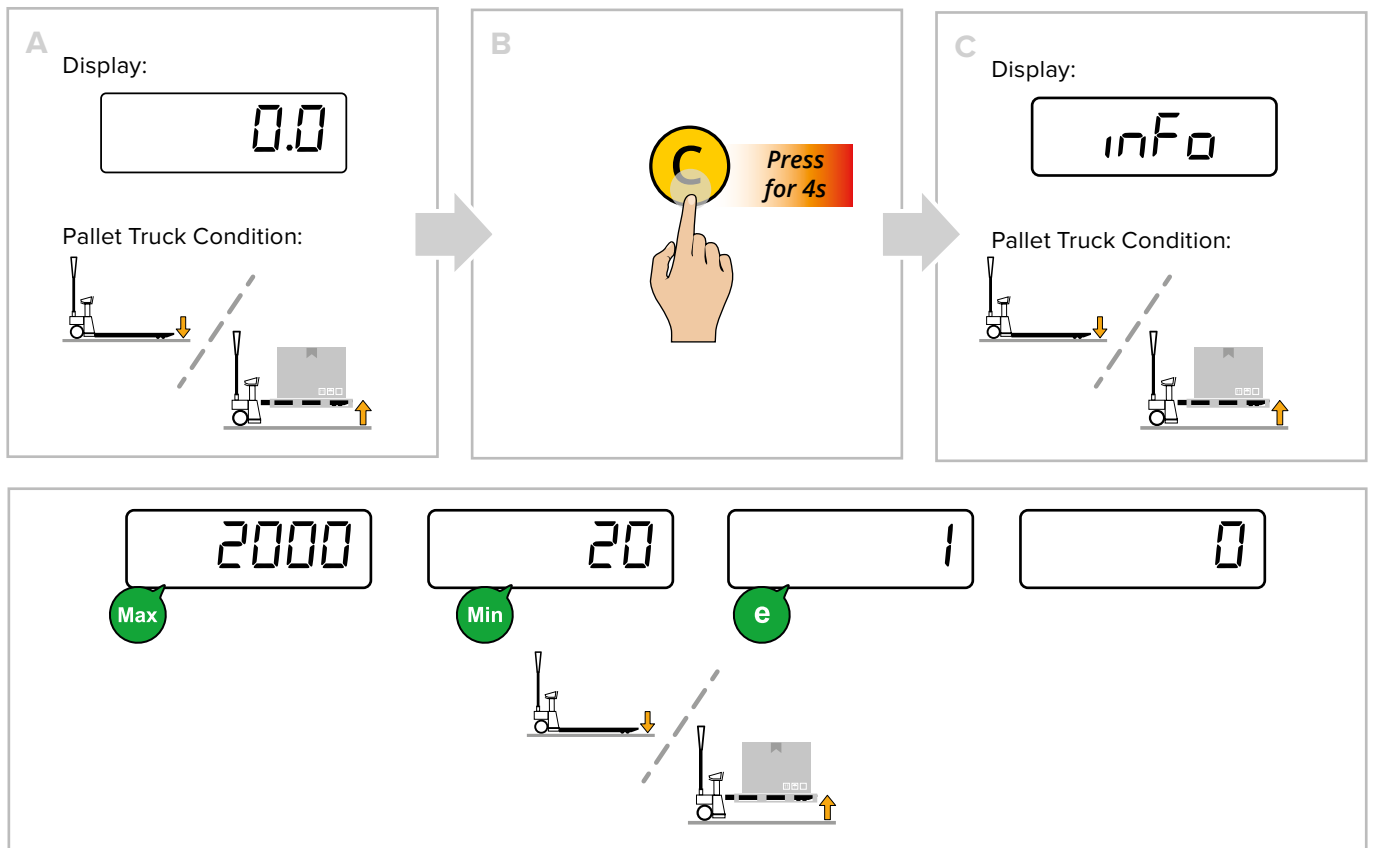

# ADDITIONAL FUNCTIONS FOR MODELS WITH NUMBER KEYPAD

## 30-tare log

This memorises the most commonly used tares (up to 30), to simplify retrieval with quick selection.

### Example

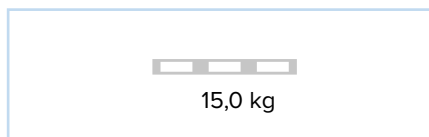

### HOW TO STORE A TARE

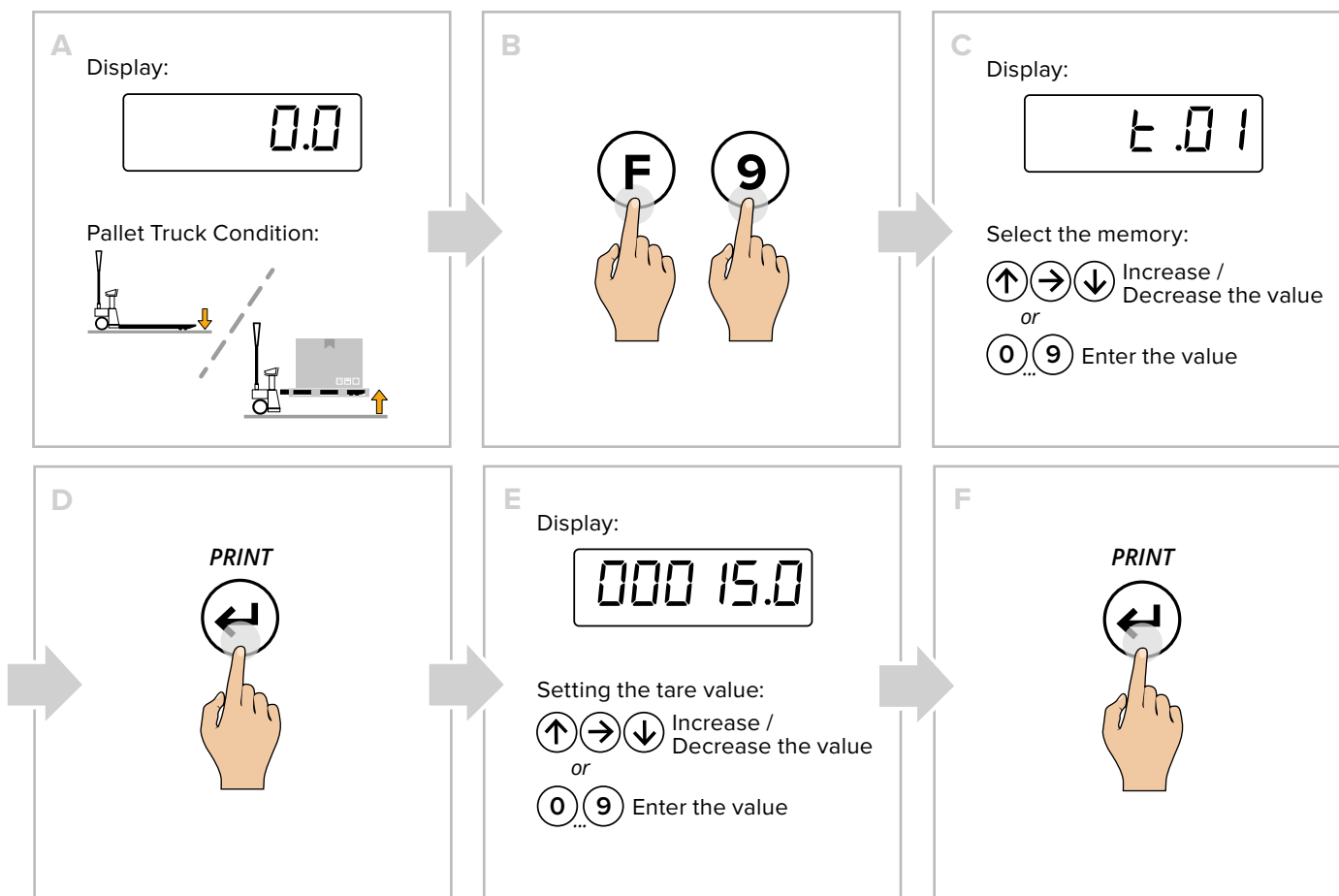



## HOW TO RETRIEVE A STORED TARE

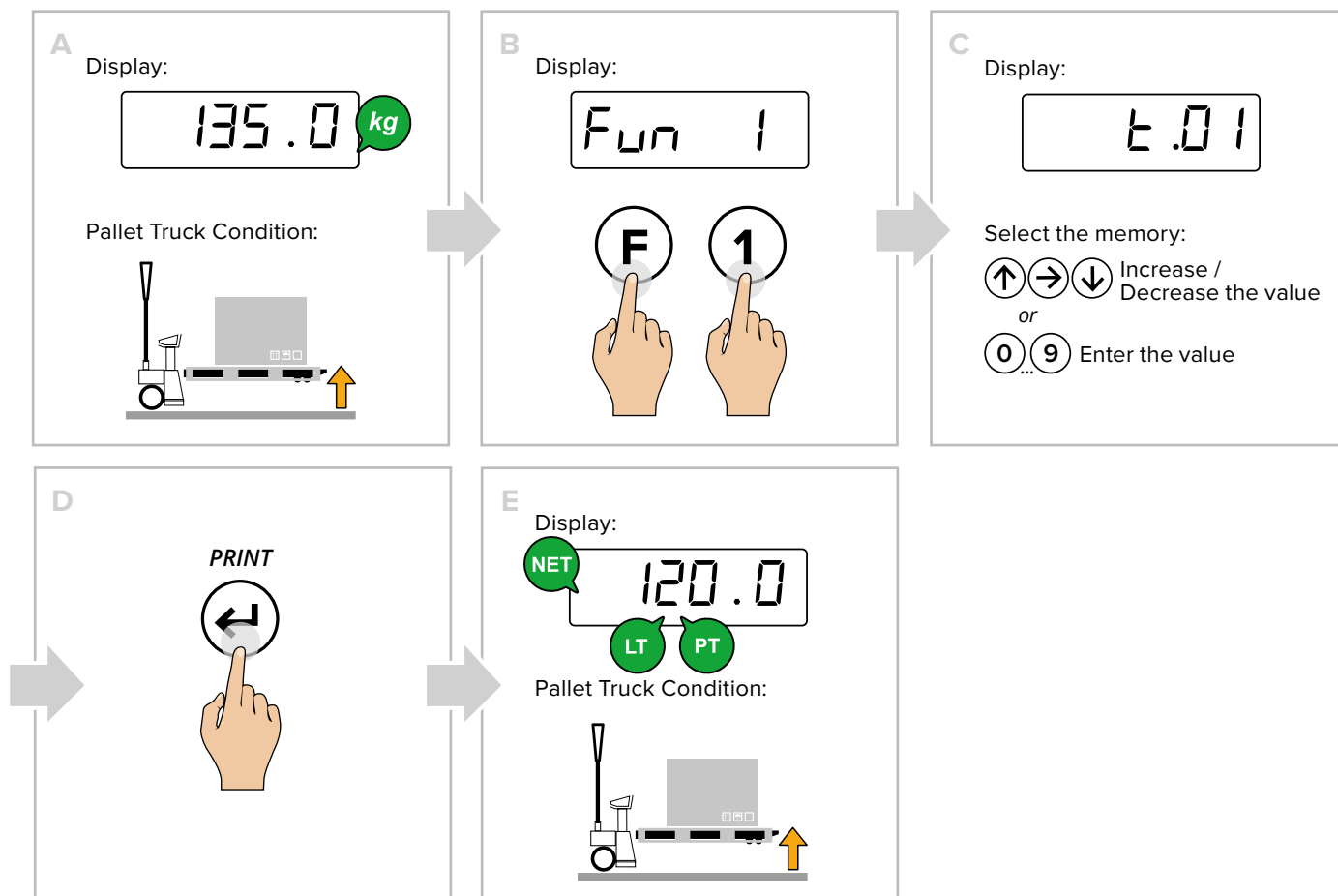

## Automatic tare deletion

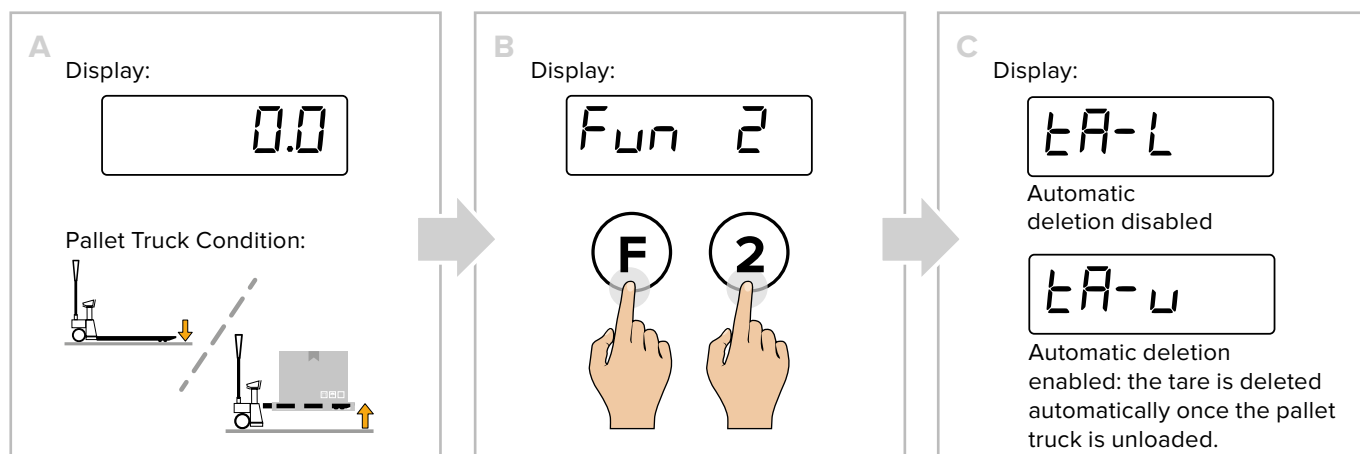

## Number IDs

The instrument has 2 memories for the temporary recording of numerical codes that can be used to identify the product, the operator, the batch, etc. These codes, if entered, will be shown on the receipt at the time of printing.

### HOW TO ENTER THE ID

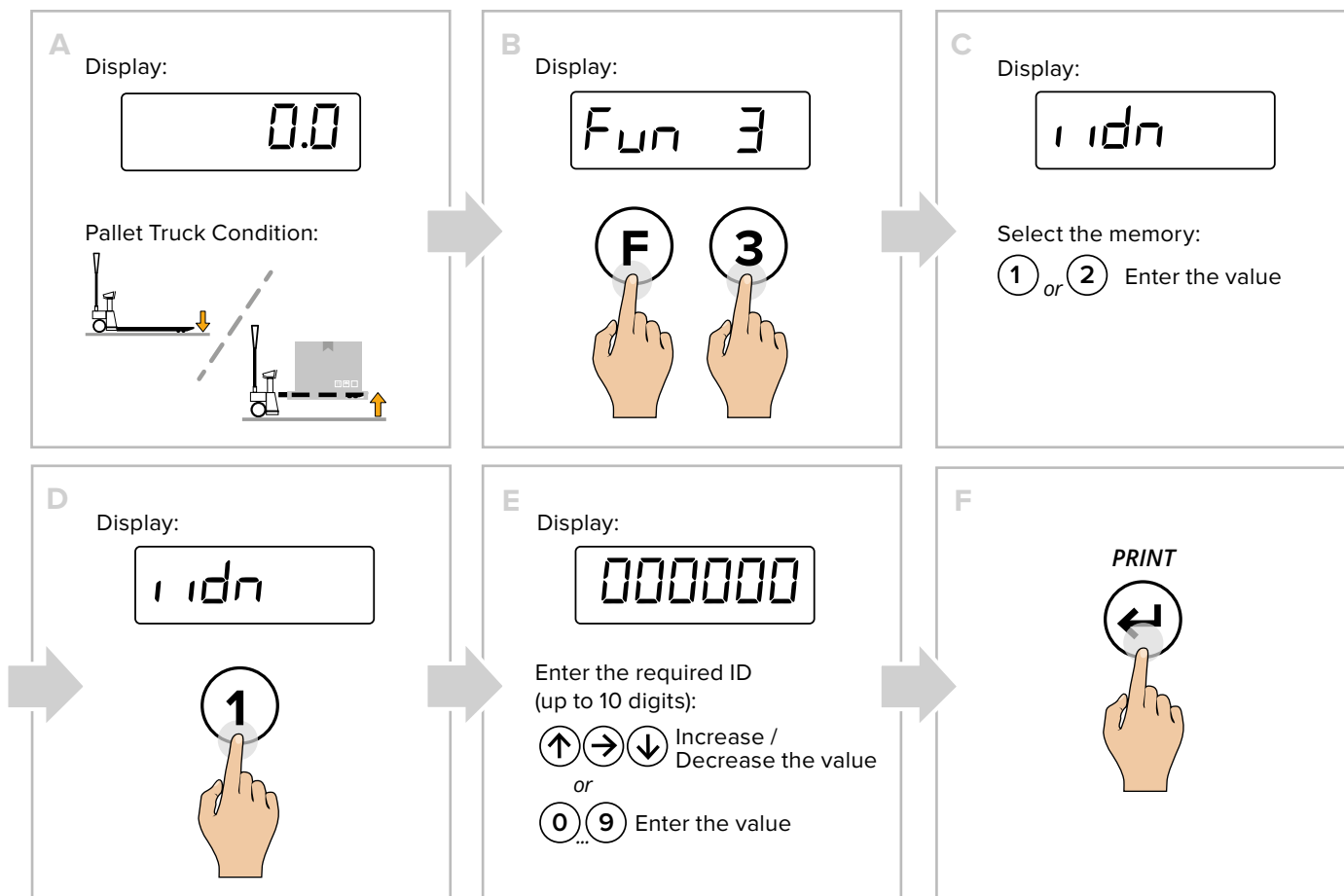

## HOW TO ENABLE AUTOMATIC ID DELETION

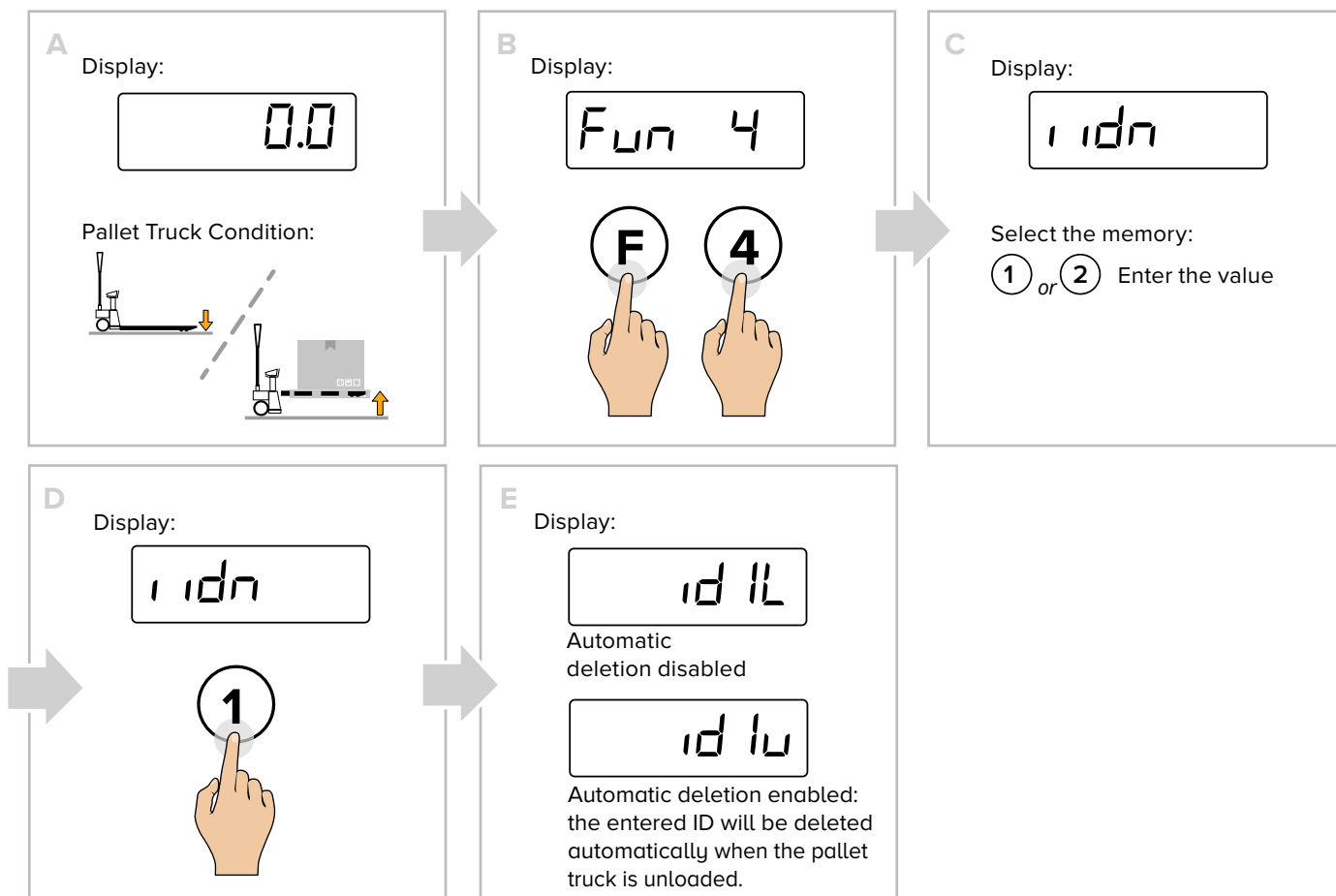

The numeric IDs are automatically reset when the scale is turned off.

## Date and time

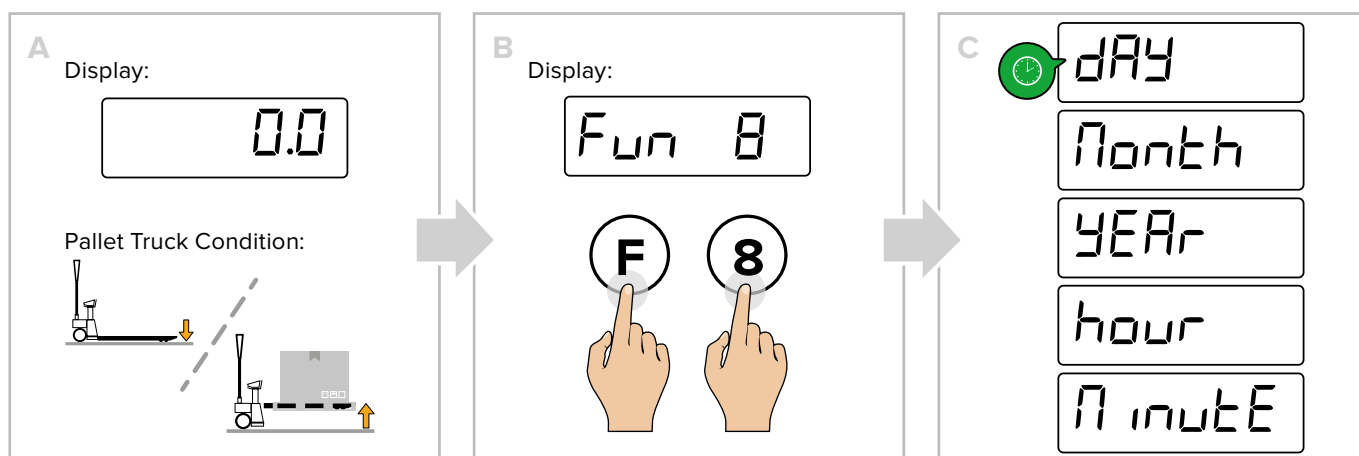

Only if the date and time option is available.



## Print (and reprint of last receipt)

### PRINT

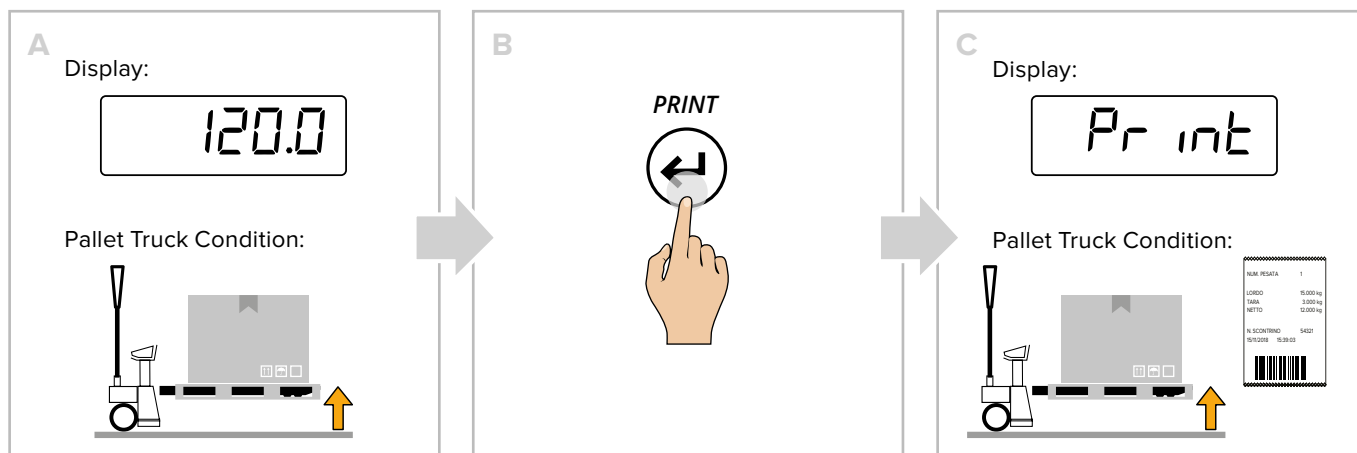

### REPRINT OF LAST RECEIPT

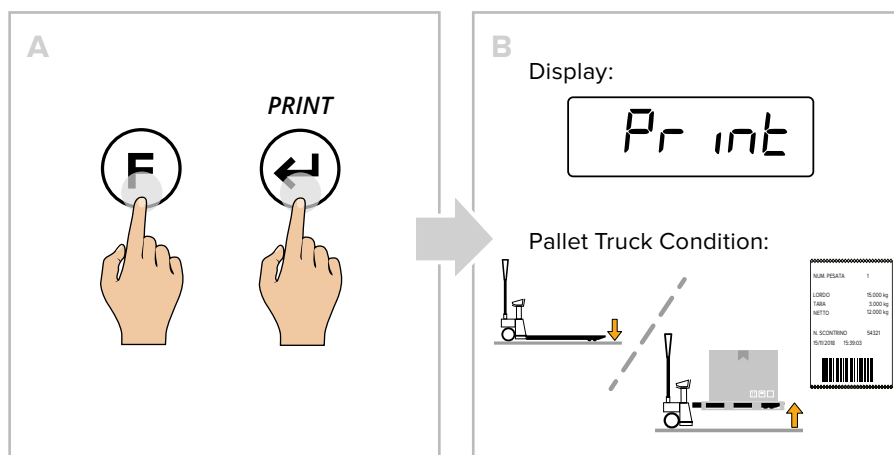

## Metrics

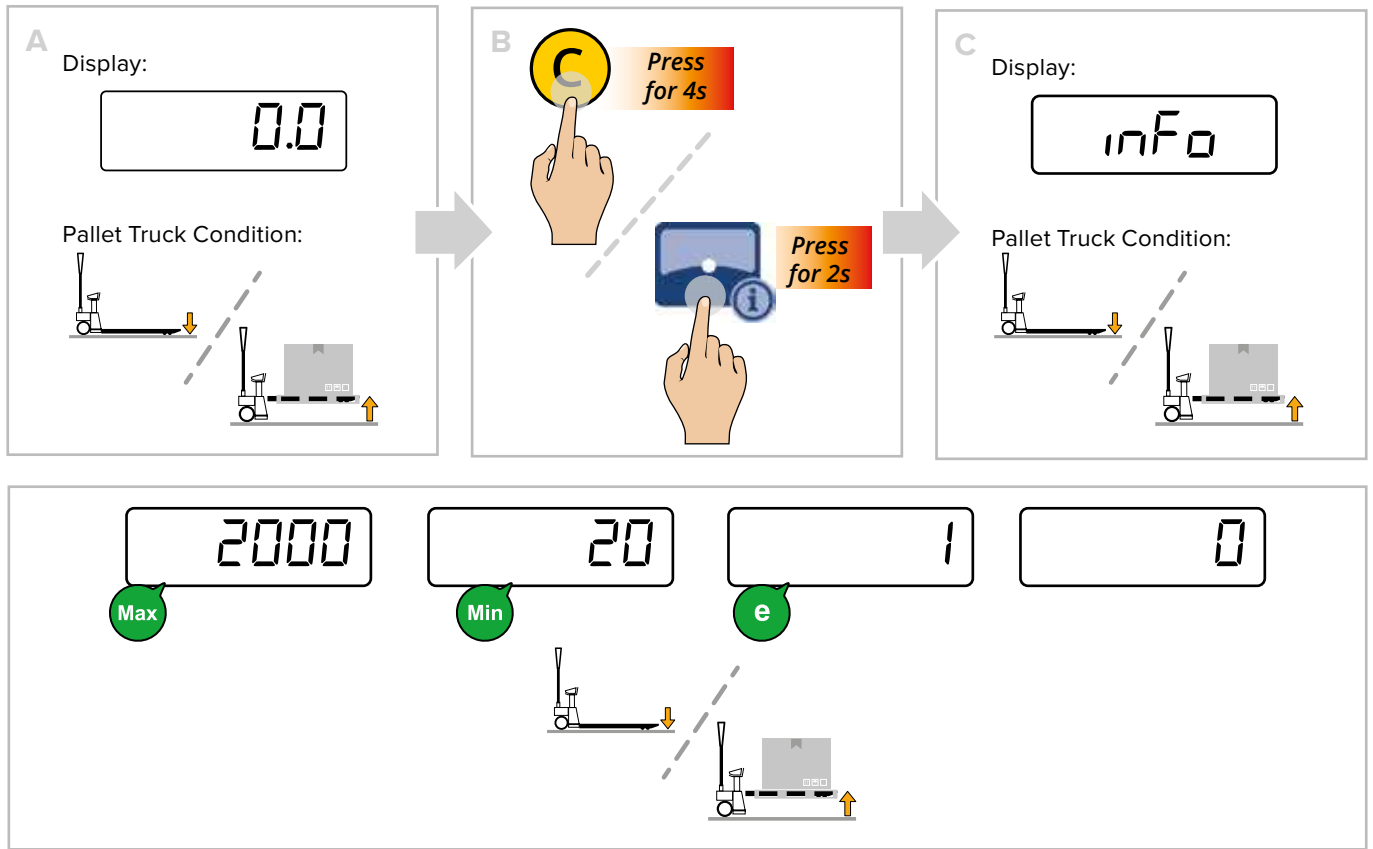

# ADVANCED SCALE FUNCTIONS

## How to access the function menu

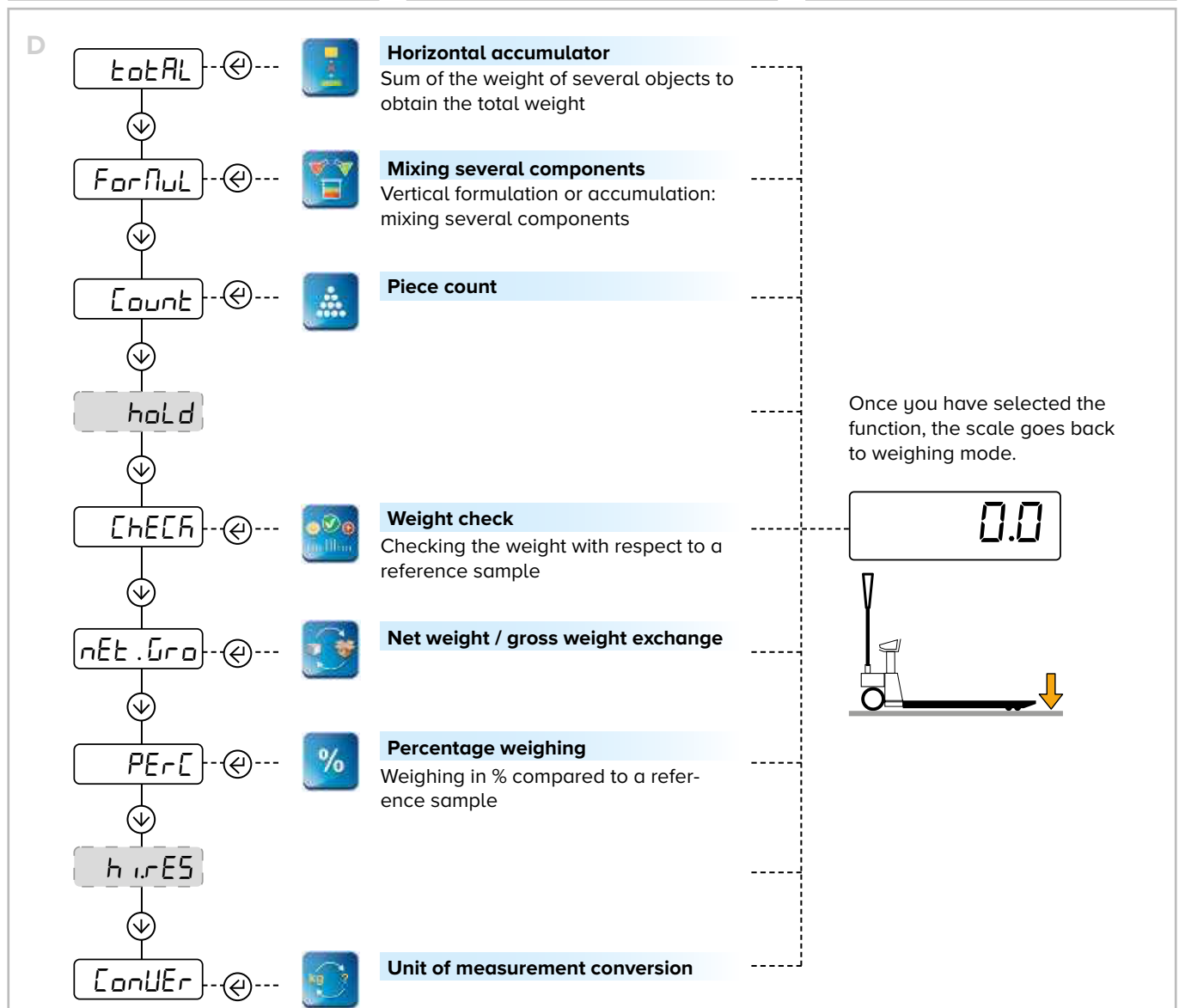
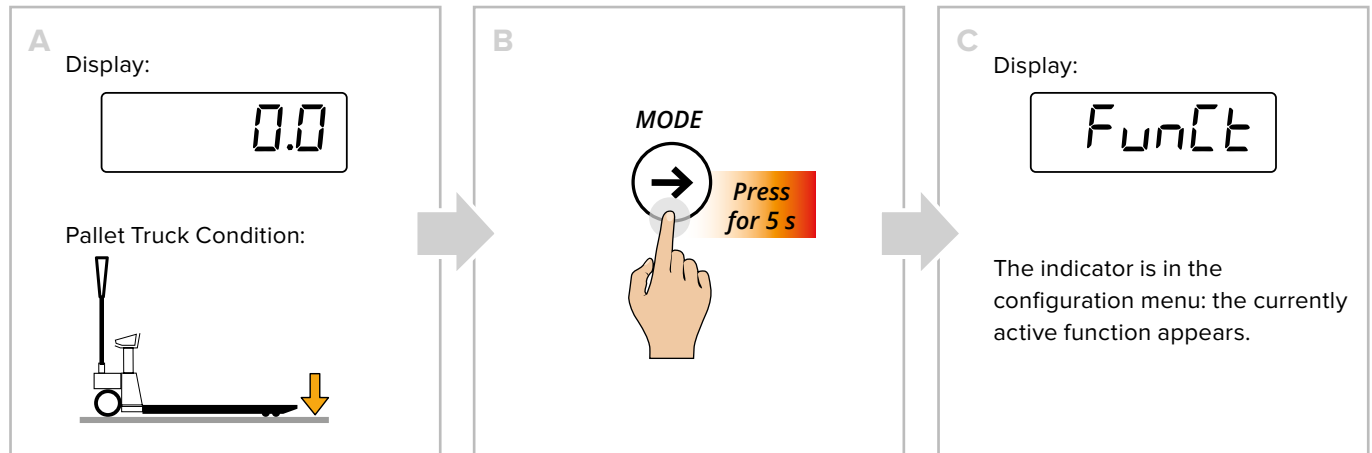

## Horizontal accumulator

### HOW TO ADD UP THE WEIGHINGS

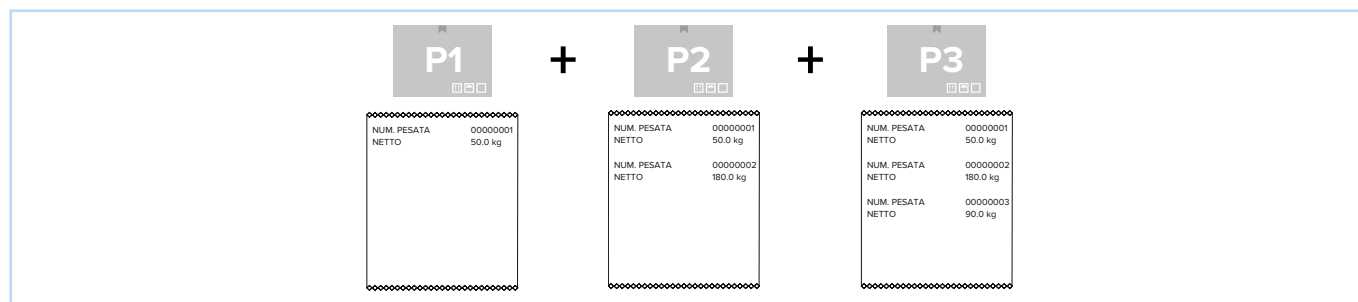
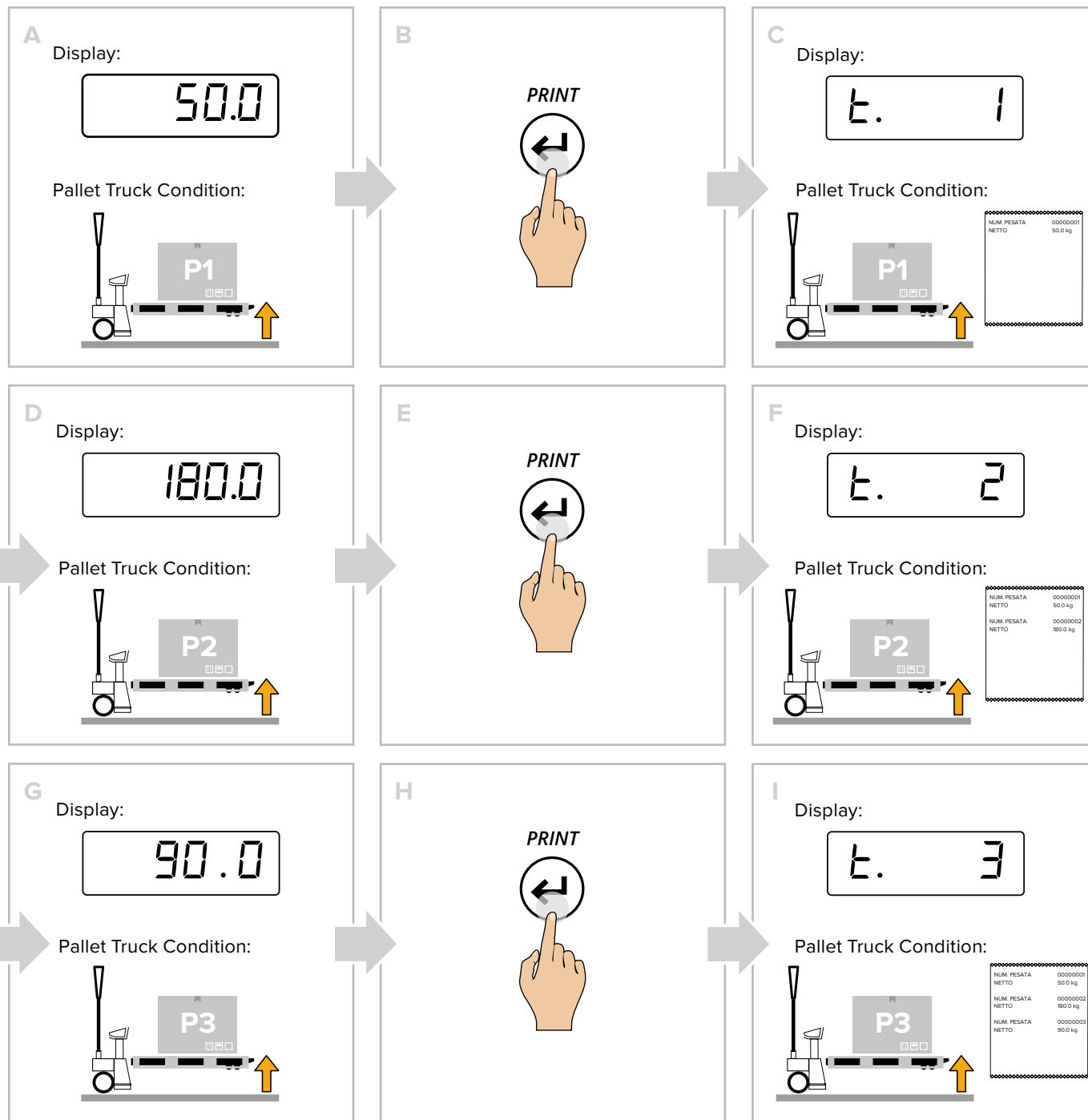

## HOW TO MOMENTARILY READ THE TOTAL

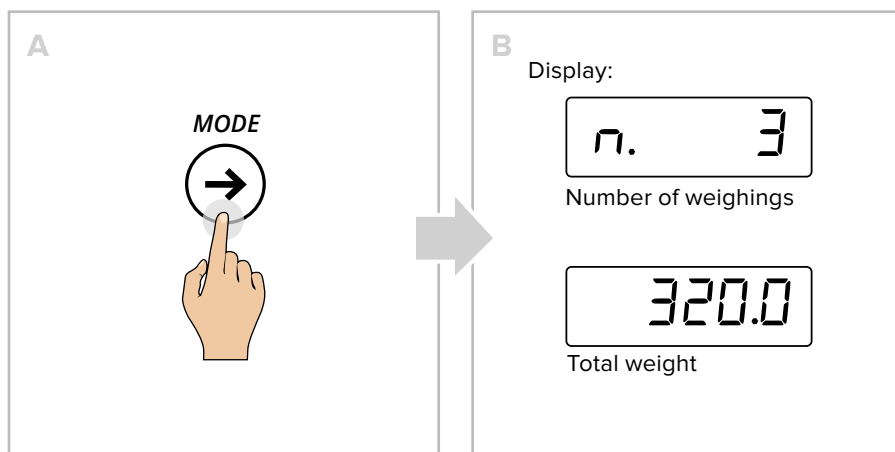

**i** With the number keyboard, pressing (F) + (7) displays the current total without printing it/resetting it.

## HOW TO END ACCUMULATION AND RESET THE TOTAL

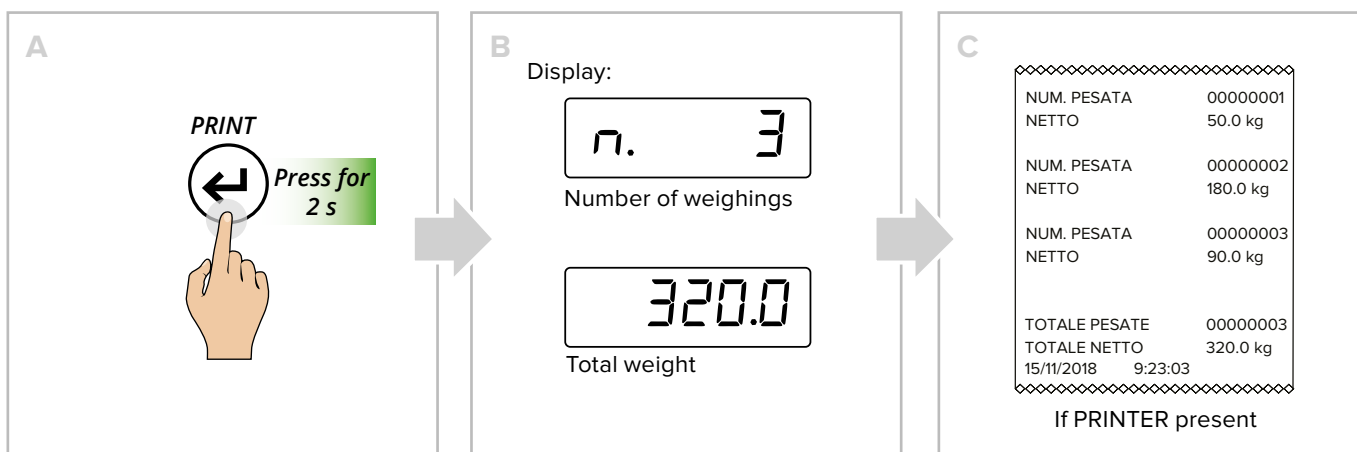

**i** With the number keyboard, pressing (F) + (7) displays the current total without printing it/resetting it.

## HOW TO PRINT AND RESET THE GRAND TOTAL

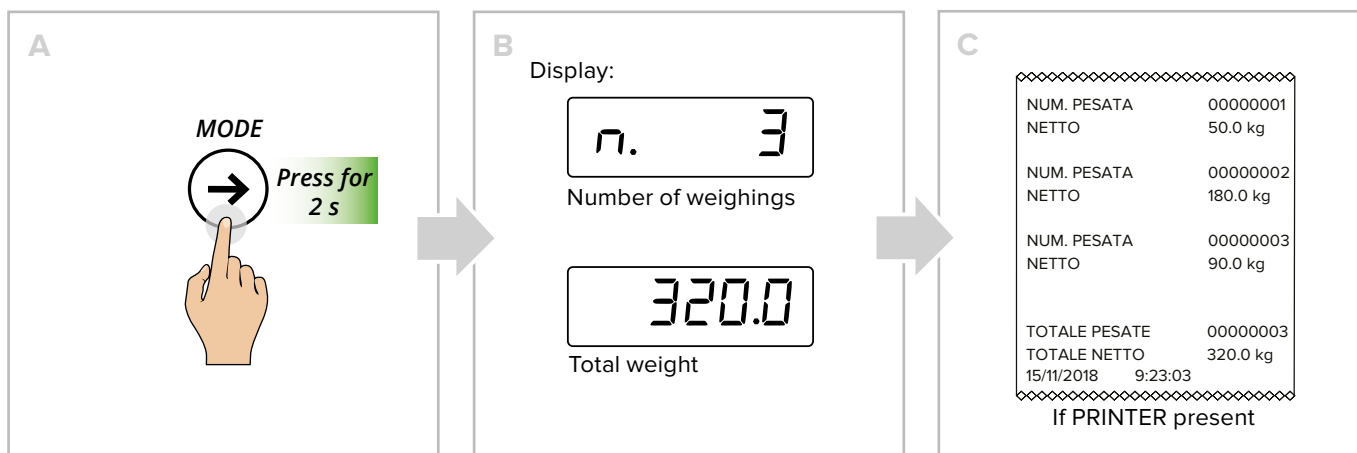

**i** With the number keyboard, pressing (F) + (6) displays the current total without printing it/resetting it.



## Mixing several components

### HOW TO ADD UP THE WEIGHINGS

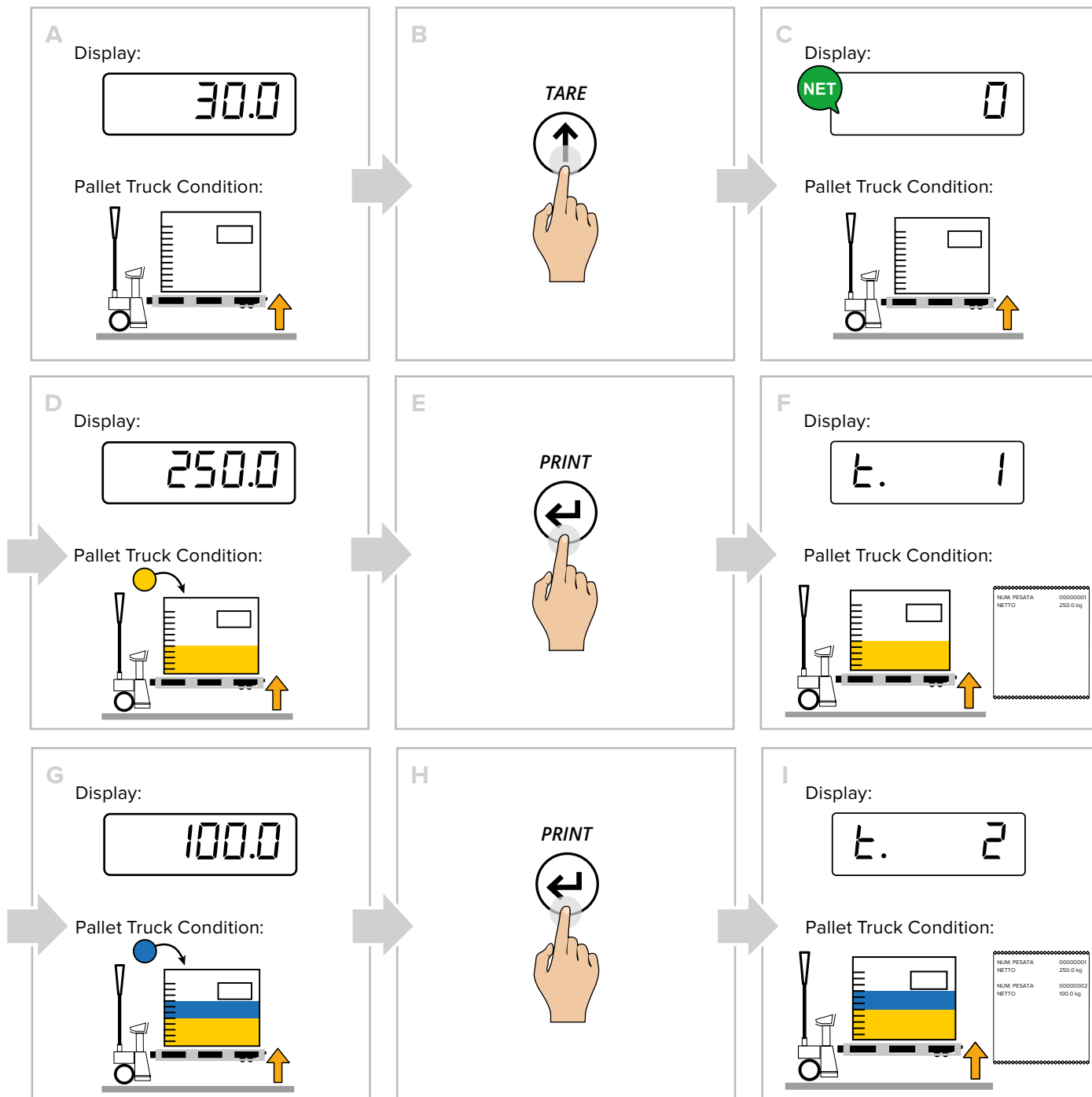

## HOW TO MOMENTARILY READ THE TOTAL

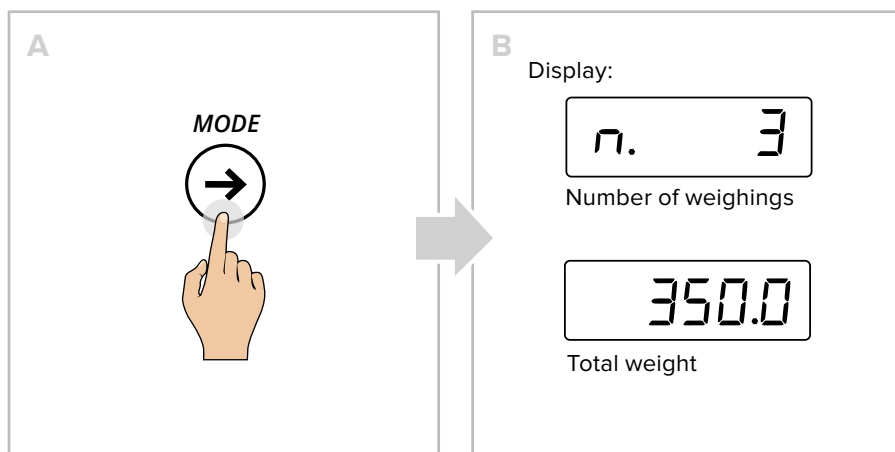

**i** With the number keyboard, pressing (F) + (7) displays the current total without printing it/resetting it.

## HOW TO END ACCUMULATION AND RESET THE TOTAL

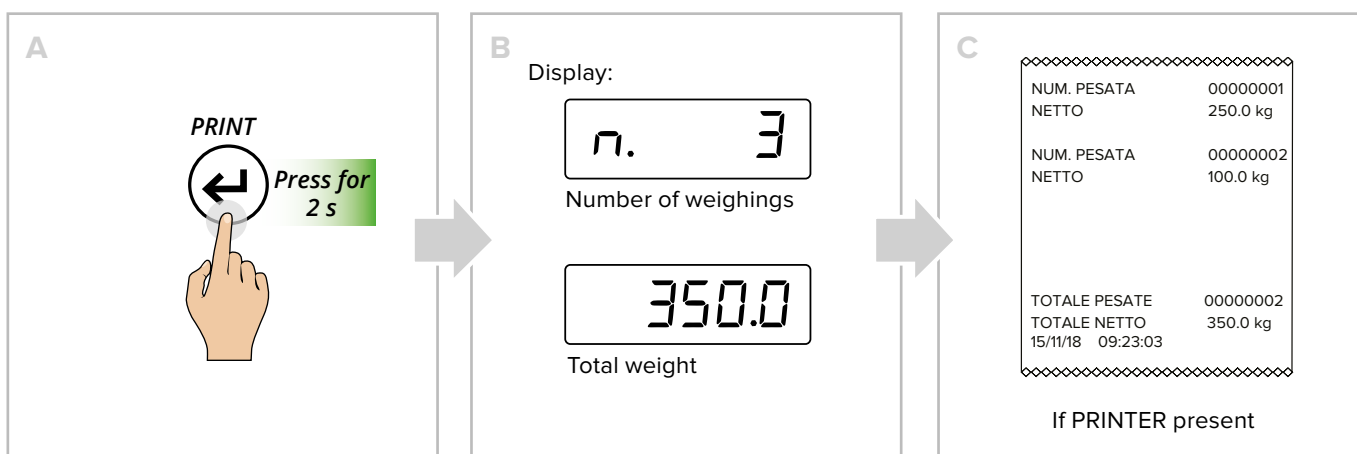

**i** With the number keyboard, pressing (F) + (7) displays the current total without printing it/resetting it.

## HOW TO PRINT AND RESET THE GRAND TOTAL

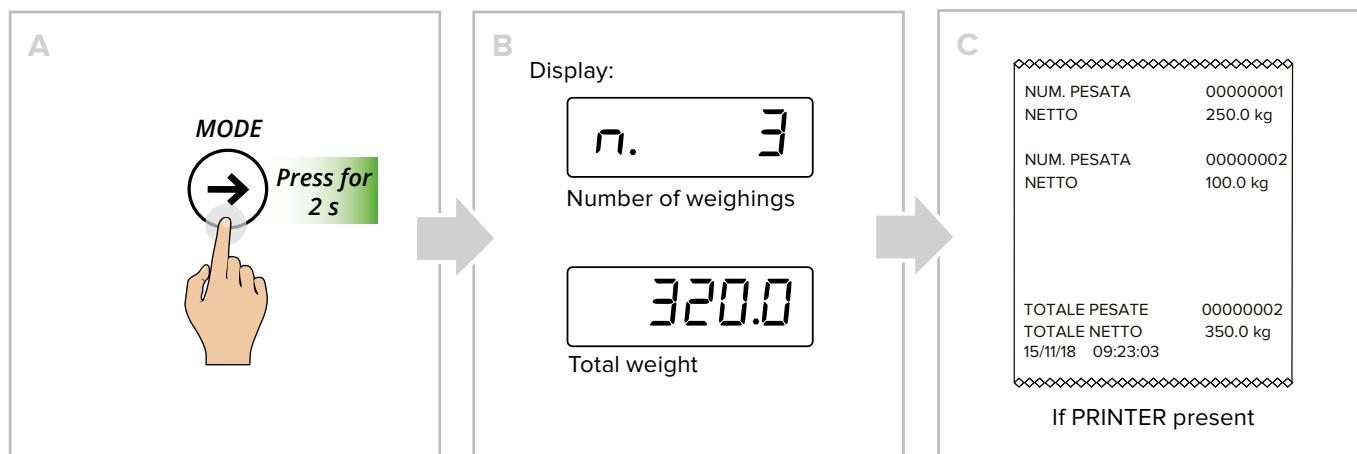

**i** With the number keyboard, pressing (F) + (6) displays the current total without printing it/resetting it.

## Piece count

### HOW TO SAMPLE AND COUNT

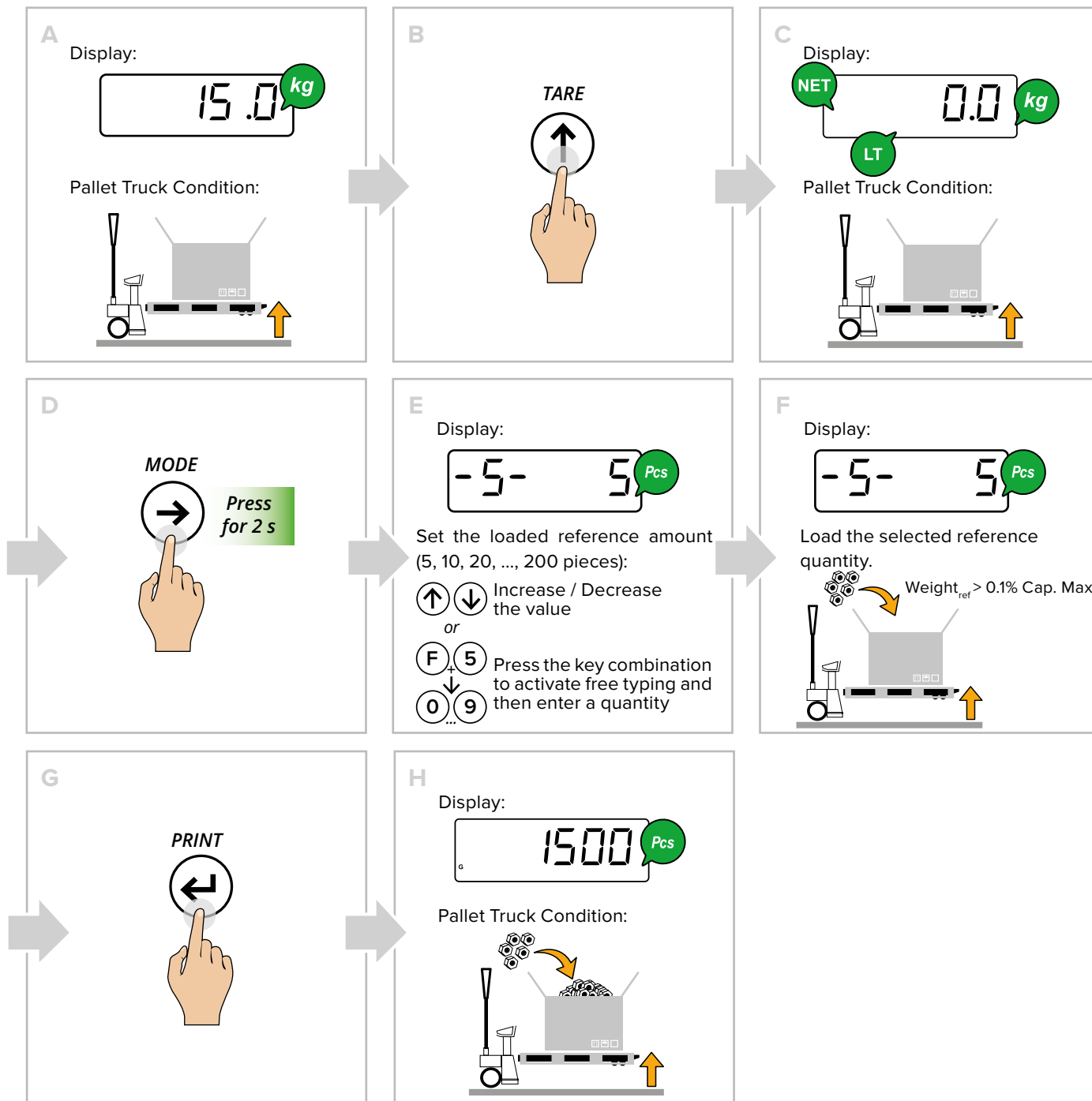

## HOW TO SWITCH FROM PIECE TO WEIGHT DISPLAY AND VICE VERSA

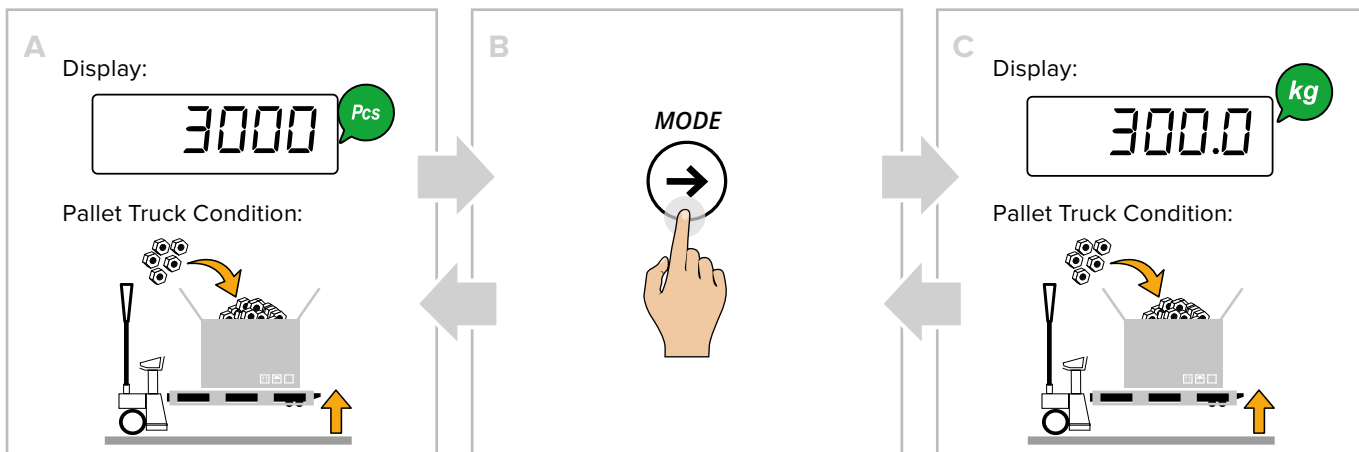

You can go from counting to weighing at any time by pressing <sup>MODE</sup>

## HOW TO ENTER THE AVERAGE UNIT WEIGHT (PMU)

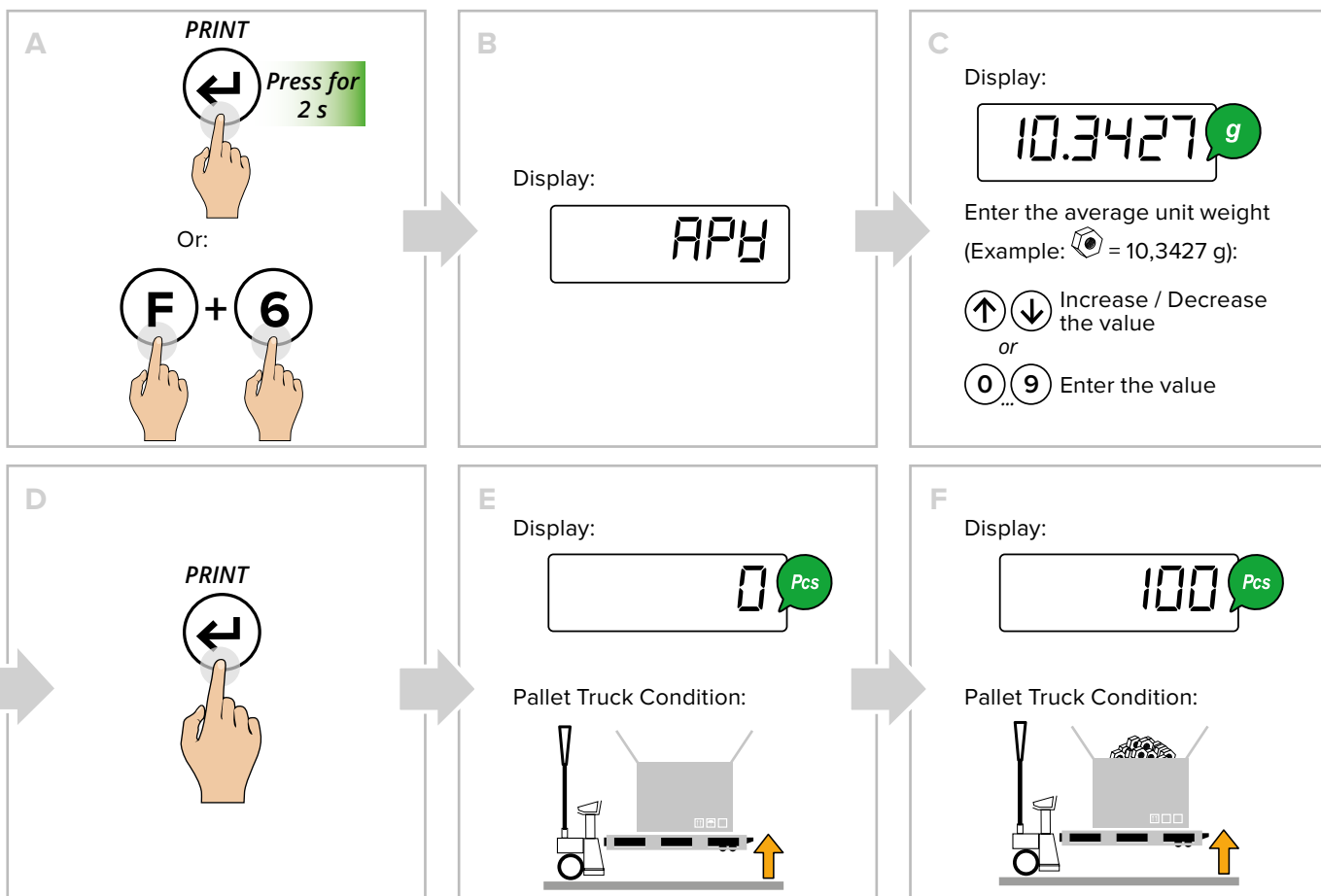

For correct counting, you must set the known tare value or tare the empty container and fill it with the pieces to count.

## TOTAL LOAD COUNT

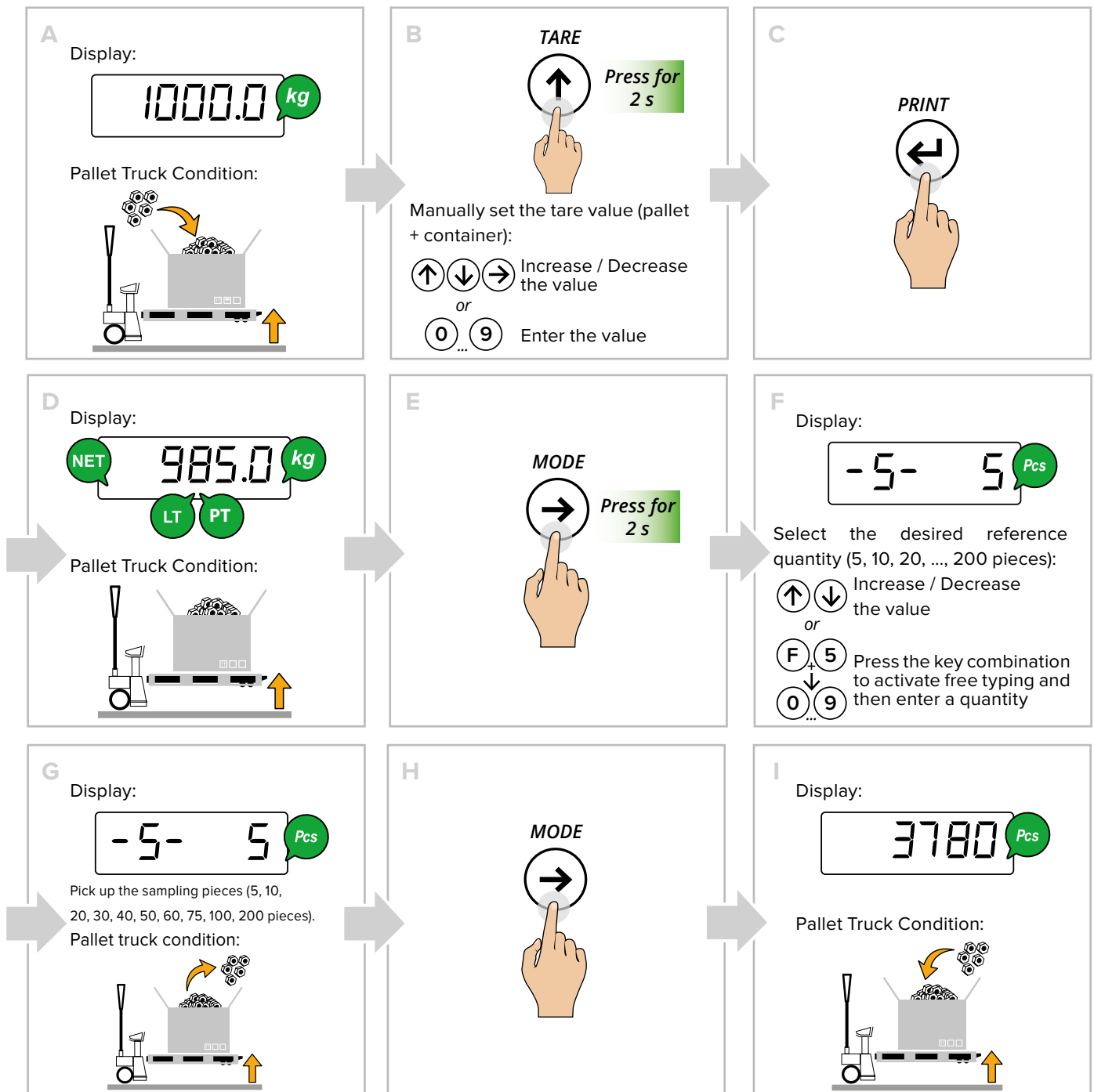

## Weight check

### HOW TO START THE CHECK WITH KNOWN REFERENCE WEIGHT

**A** Display:

0.0 kg

Pallet Truck Condition:

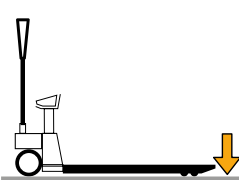

**B**

MODE



Press for 2 s







**C** Display:

tArGET kg

**D** Display:

t00000 kg

Manually set the value:



 Increase / Decrease the value  
 or  
 ...  Enter the value

**E**

PRINT









**F** Display:

L00000 kg

Enter the lower tolerance:



 Increase / Decrease the value  
 or  
 ...  Enter the value

**G**

PRINT









**H** Display:

h00000 kg

Enter the higher tolerance:



 Increase / Decrease the value  
 or  
 ...  Enter the value

**I**

PRINT





**Example 1:**  
 To check a weight of 1000 g with +/- 5 g tolerance (that is, between 995 g and 1005 g), set:  
 t0 1000  
 L00005  
 h00005

**Example 2:**  
 To check a weight of 500 g with +/- 10 g / -20 g tolerance (that is, between 480 g and 510 g), set:  
 t00500  
 L00020  
 h000 10

## HOW TO START THE CHECK WITH AUTOMATIC TARGET ACQUISITION

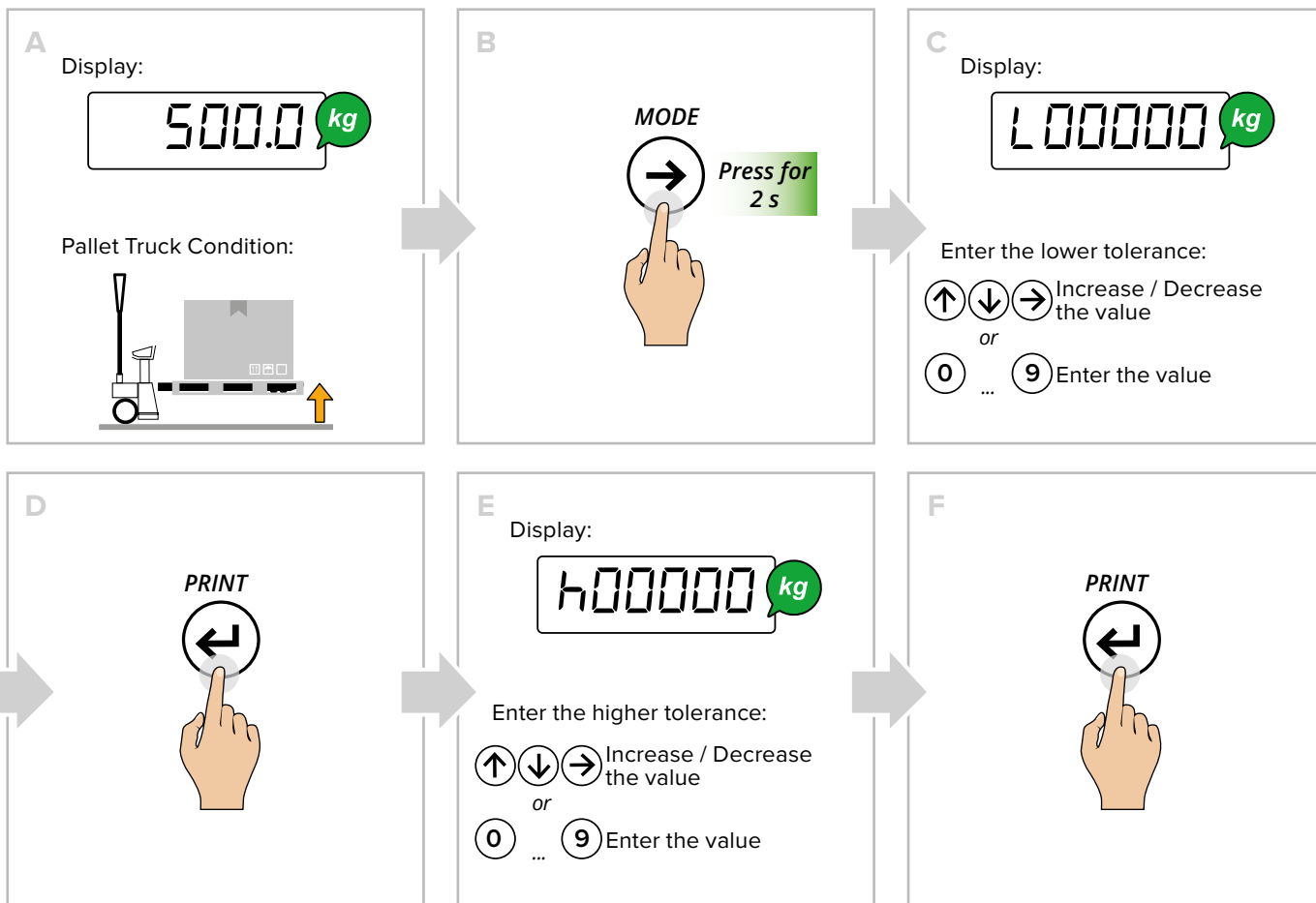

## HOW TO CHECK THE WEIGHT

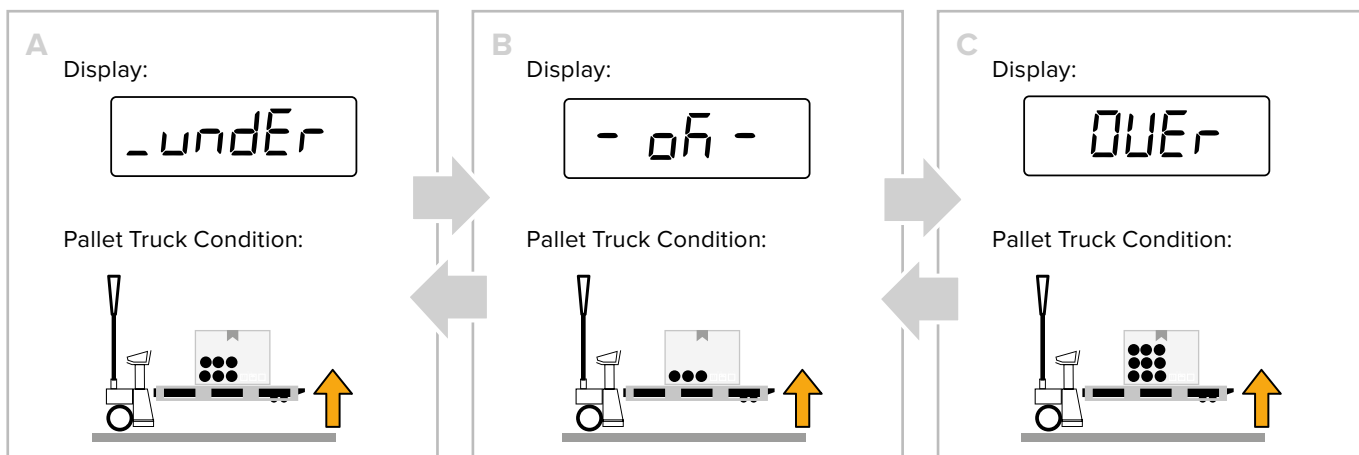

## HOW TO UPDATE THE NOMINAL WEIGHT WITH KNOWN REFERENCE WEIGHT

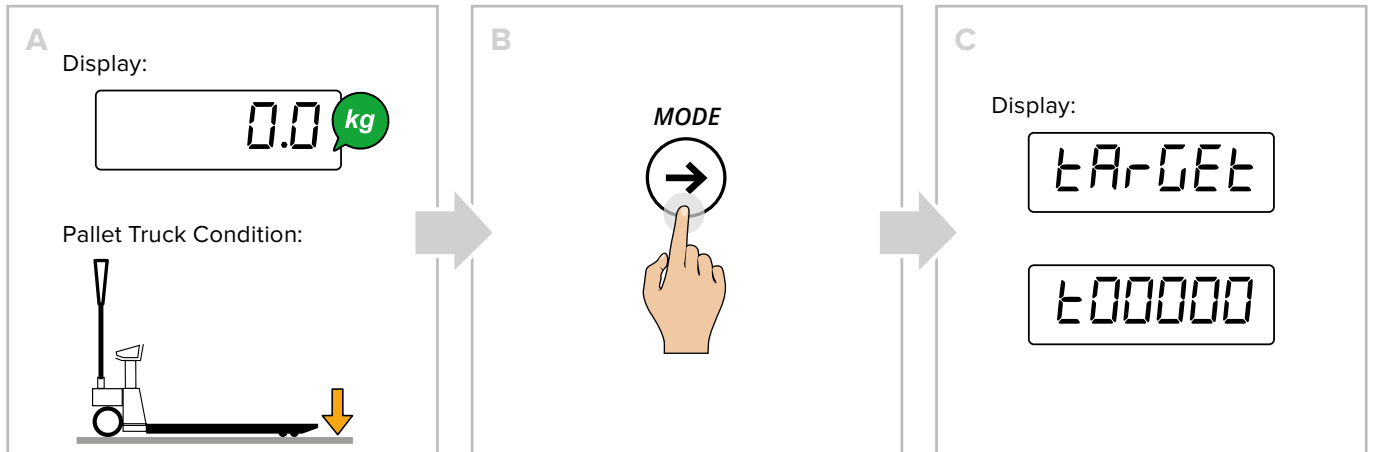

## HOW TO UPDATE THE NOMINAL WEIGHT WITH AUTOMATIC TARGET ACQUISITION

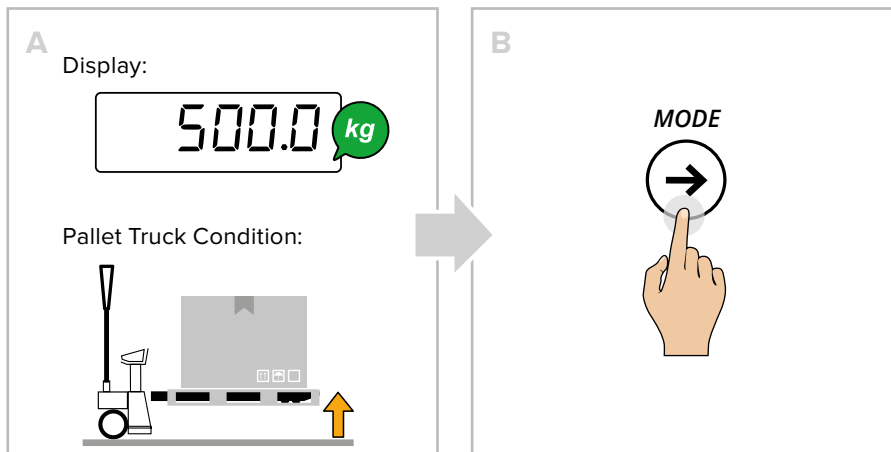



## HOW TO EDIT THE CHECK THRESHOLDS

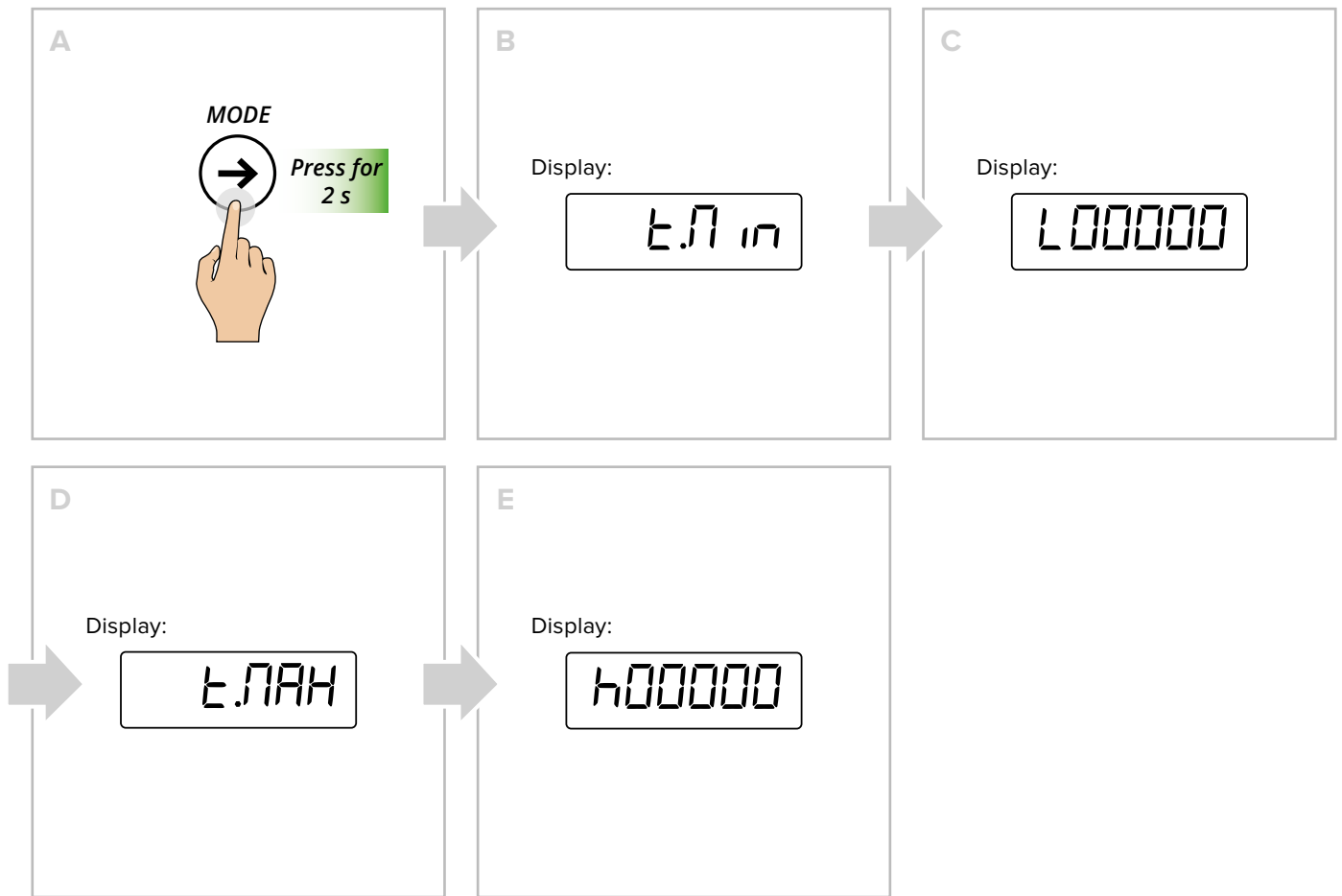

## Exchange between net weight and gross weight

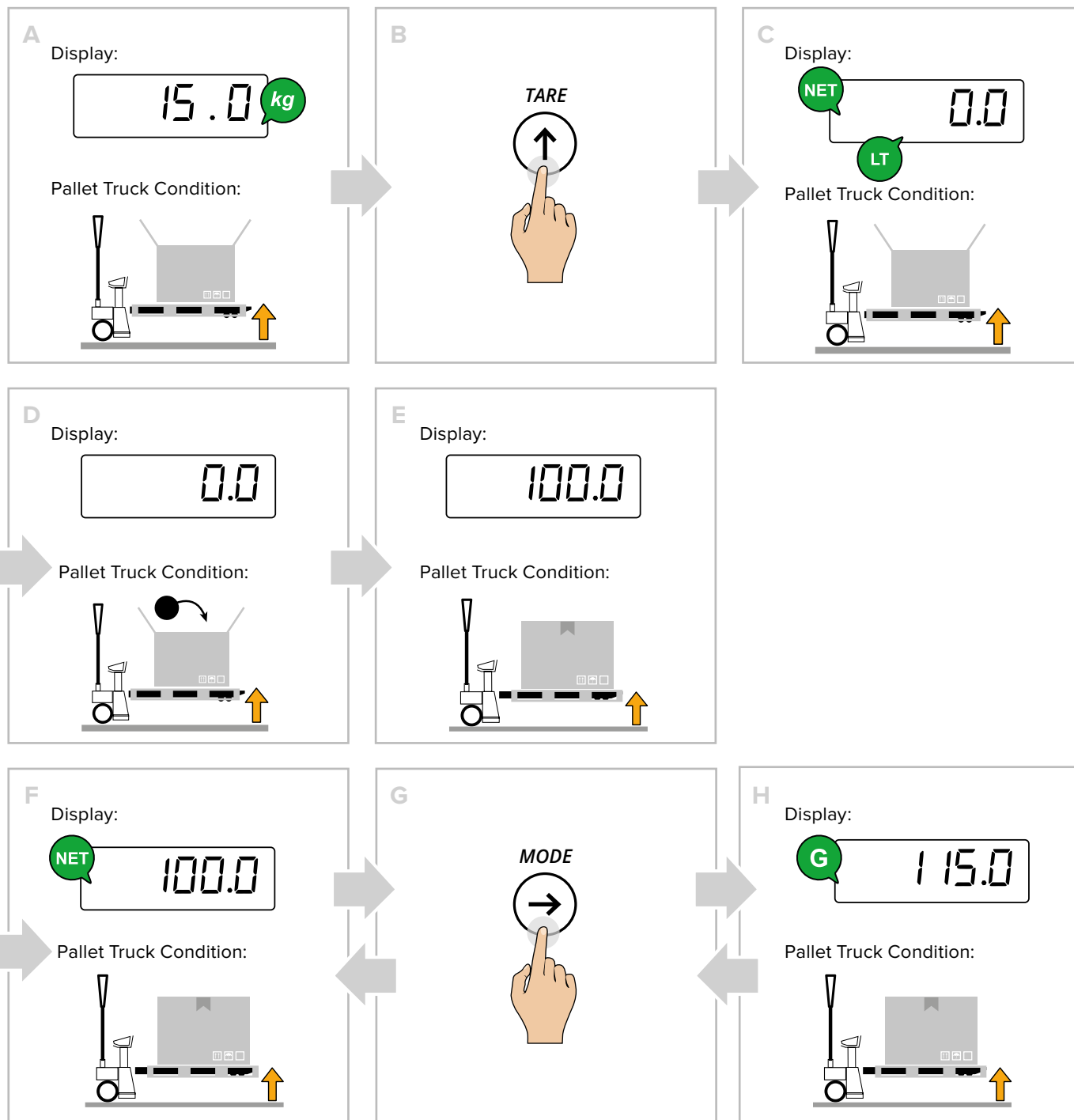

You can go from net weight to gross weight at any time by pressing <sup>MODE</sup> →.



## Percentage weighing

### PERCENTAGE CHECK

#### I. How to acquire the 100% reference

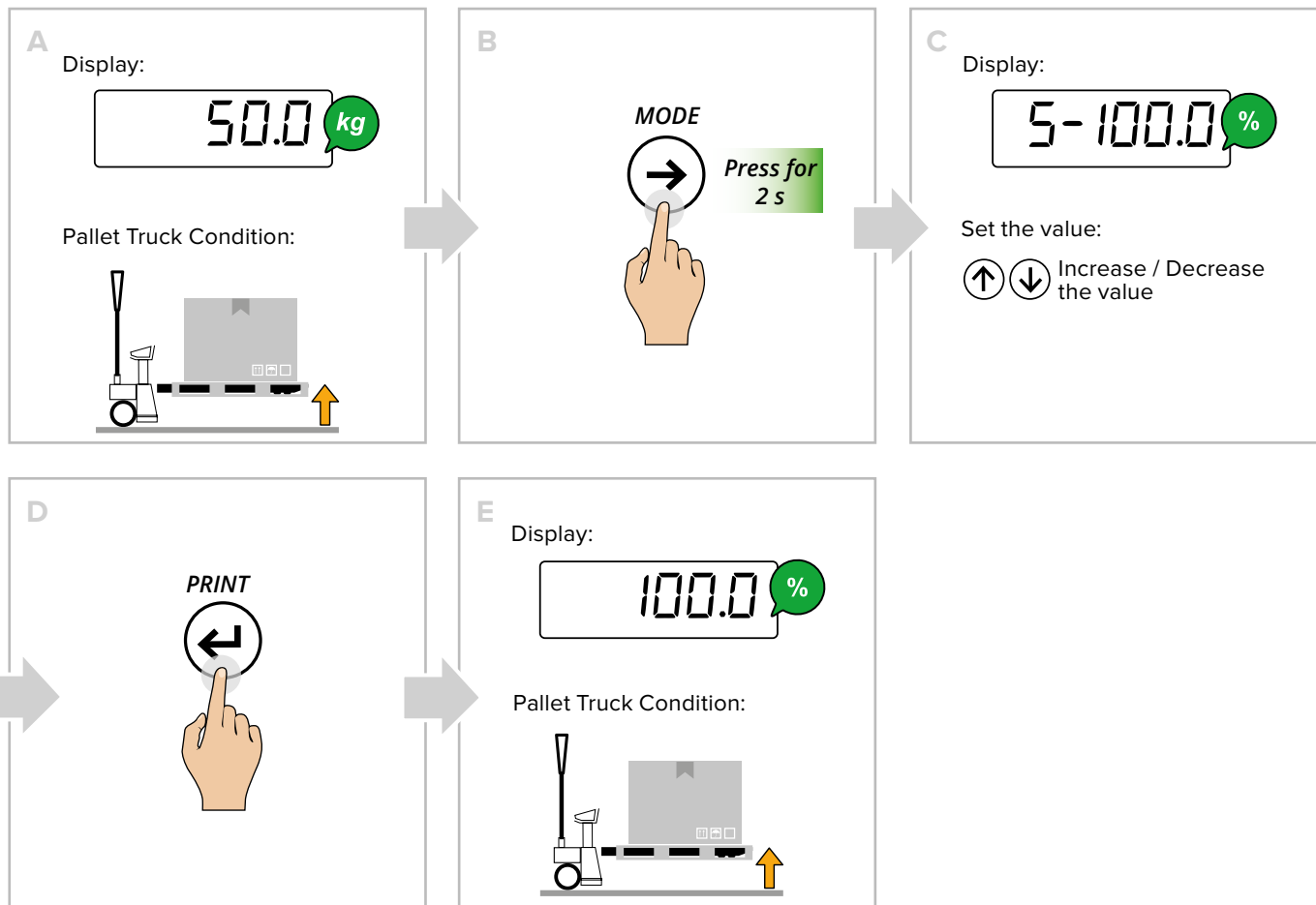

#### II. How to check the weight

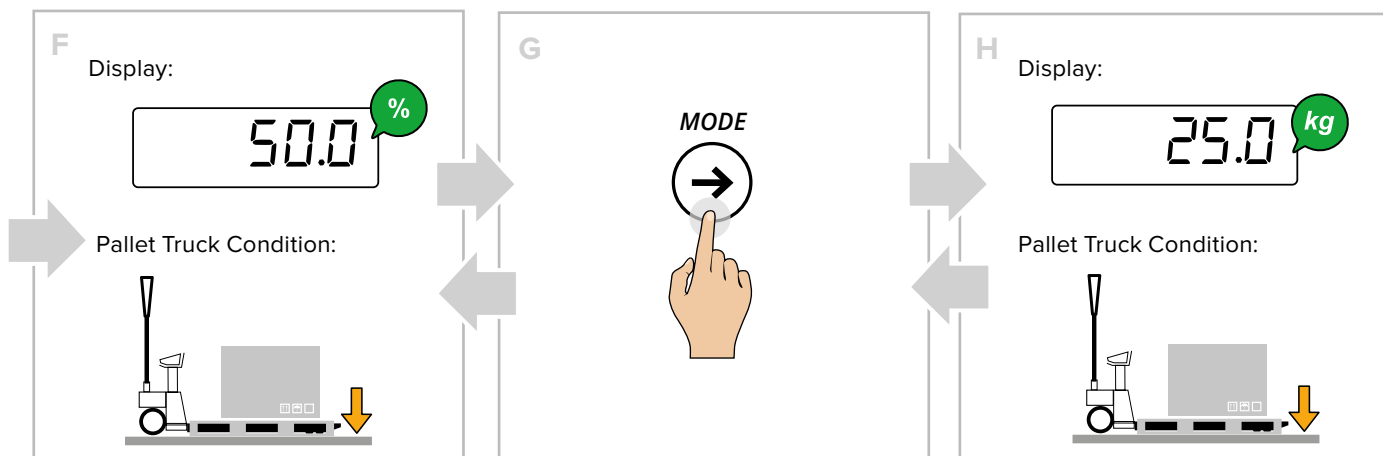

You can go from weight in % to weight in kg at any time by pressing .



## PERCENTAGE METERING

Example of formula:

**Product: RP28K**

1. 2127A3 - 50%

2. 23AB4 - 30%

3. Water - 20%

**Meter 500 kg**

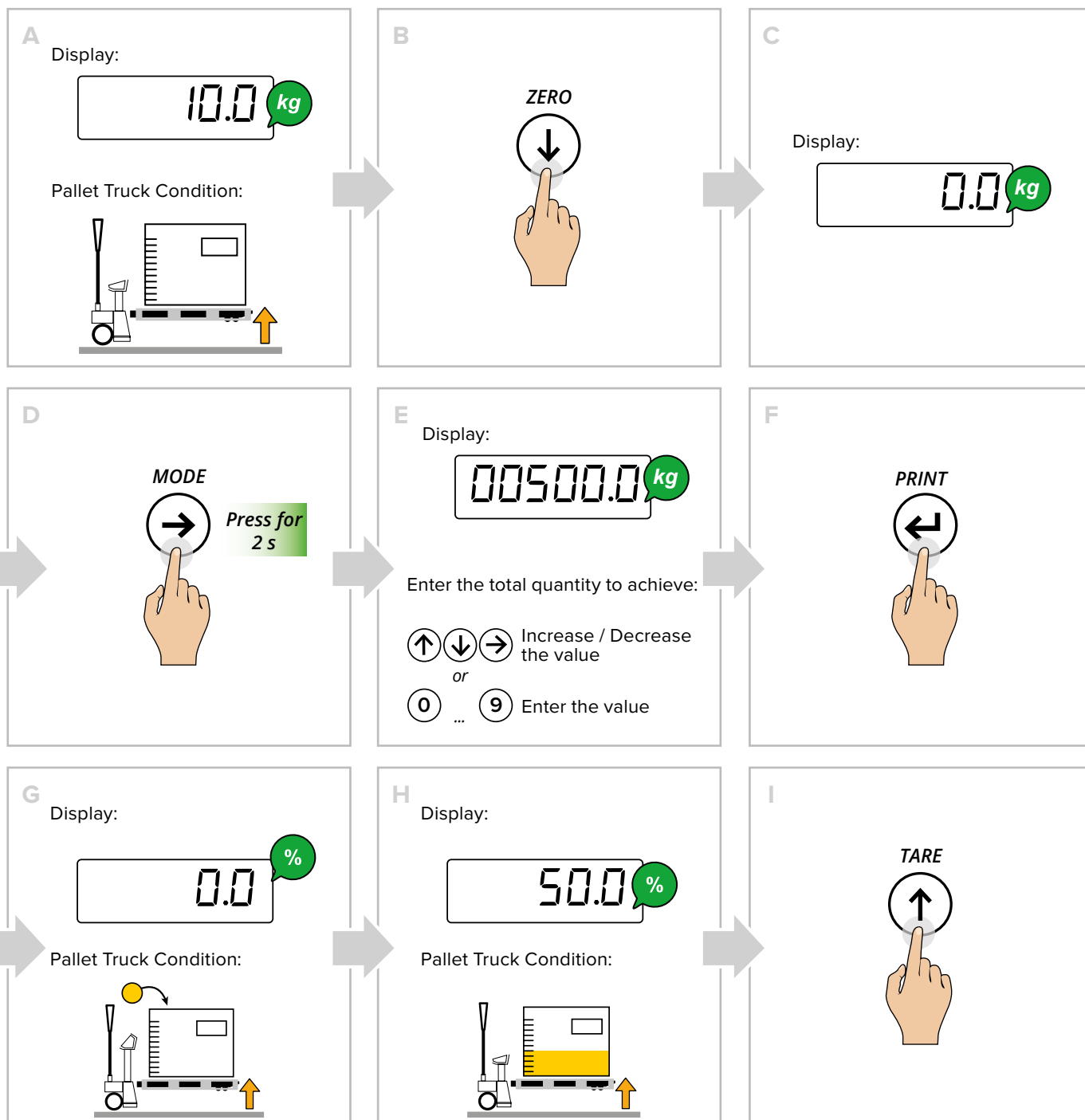

continue →

**J**

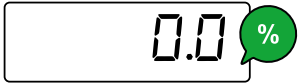
Display: 

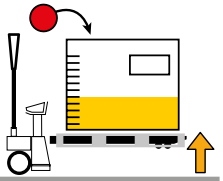
Pallet Truck Condition: 

**K**

Display: 

Pallet Truck Condition: 

**L**





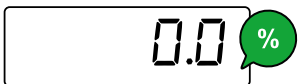

**M**

Display: 

Pallet Truck Condition: 

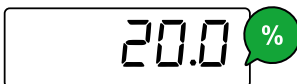
**N**

Display: 

Pallet Truck Condition: 

**O**







**P**

Display: 

Pallet Truck Condition: 

**Q**





**R**

Display: 

Pallet Truck Condition: 



You can go from weight in % to weight in kg at any time by pressing <sup>MODE</sup> .

## Unit of measurement conversion

### HOW TO CONVERT THE UNIT OF MEASUREMENT INTO POUNDS (STANDARD MODE)

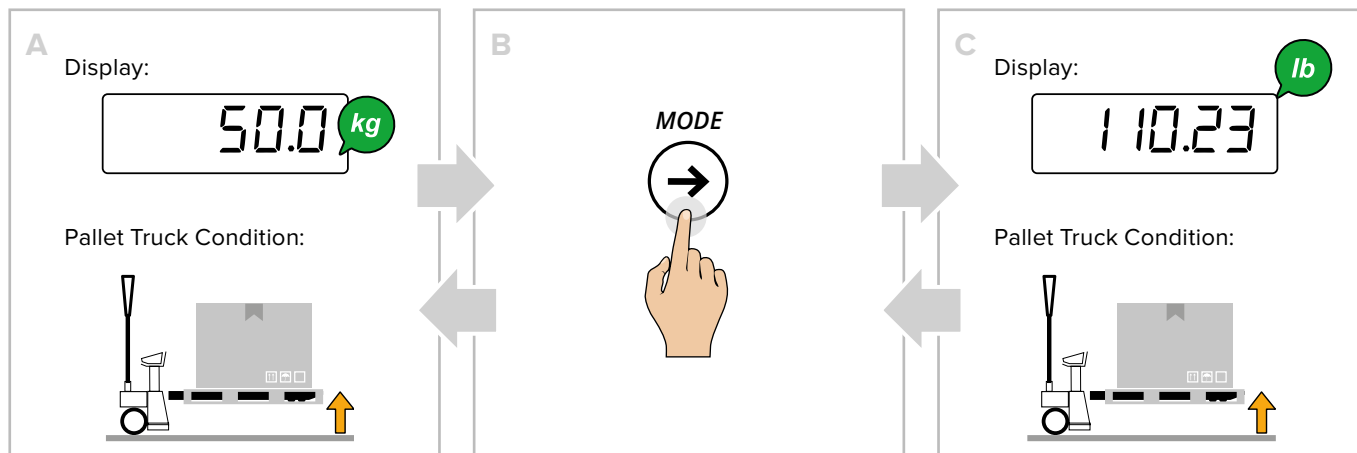

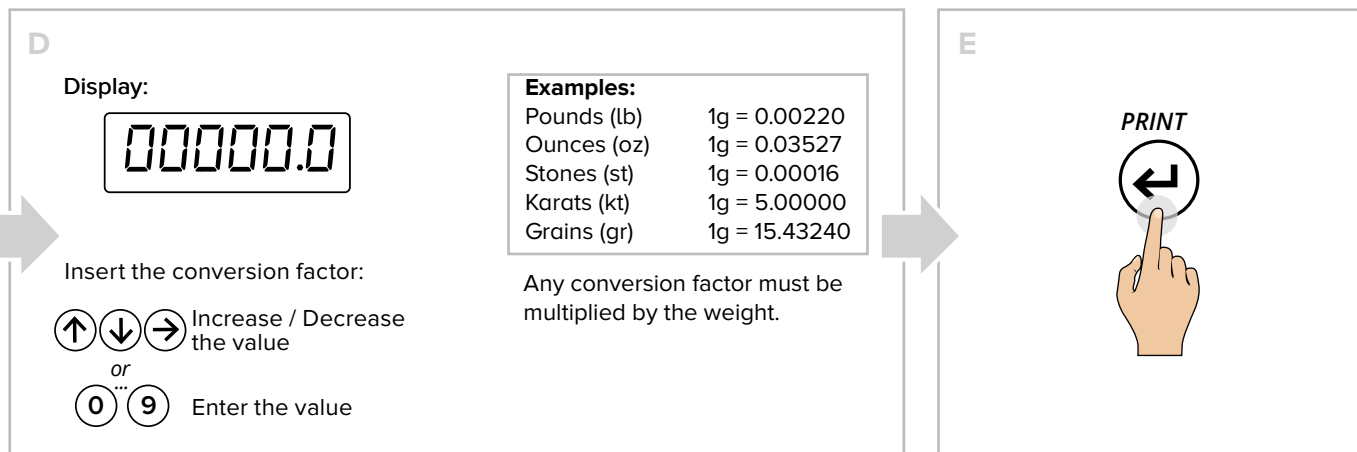
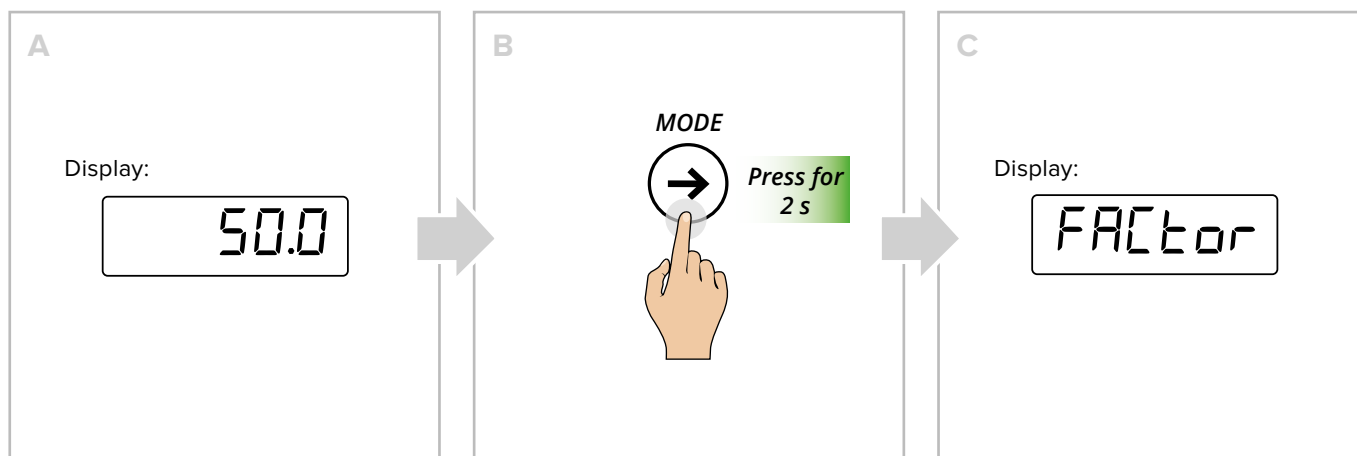

You can go from weight in kg to weight in pounds at any time by pressing .

### HOW TO CONVERT THE UNIT OF MEASUREMENT WITH FREE CONVERSION FACTOR

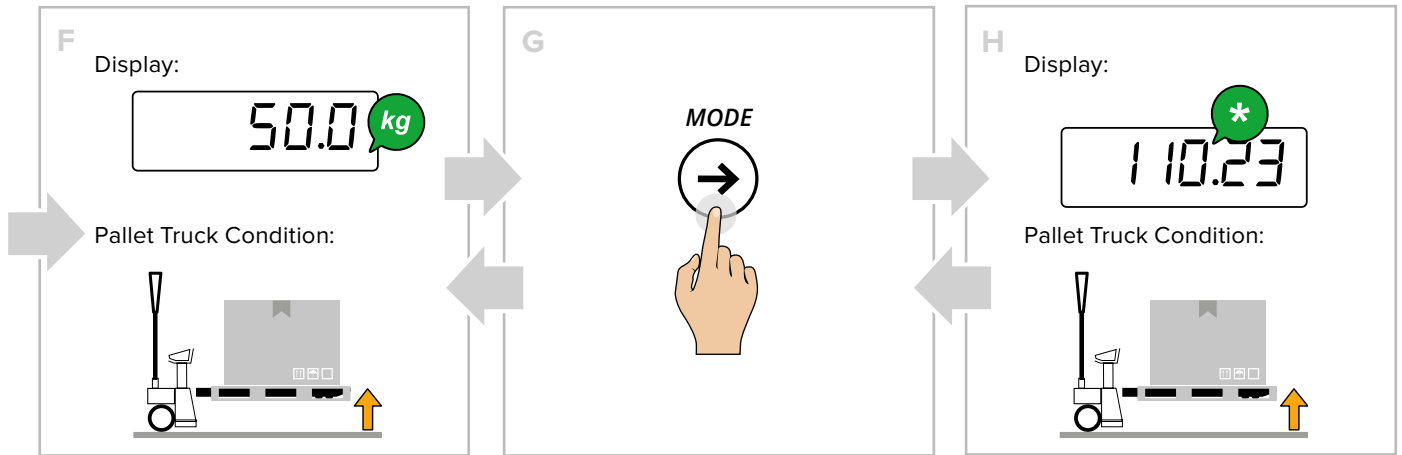

continue 



**i** You can convert the unit of measurement with free conversion factor at any time by pressing **MODE** .

## METROLOGICAL SCALE INFORMATION

### 1. Turn off the scale

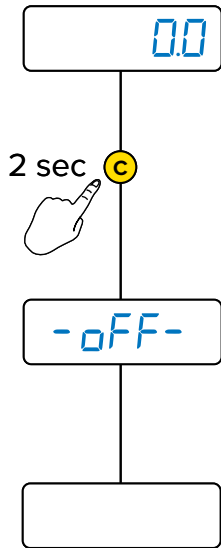

### 2. Follow the procedure:

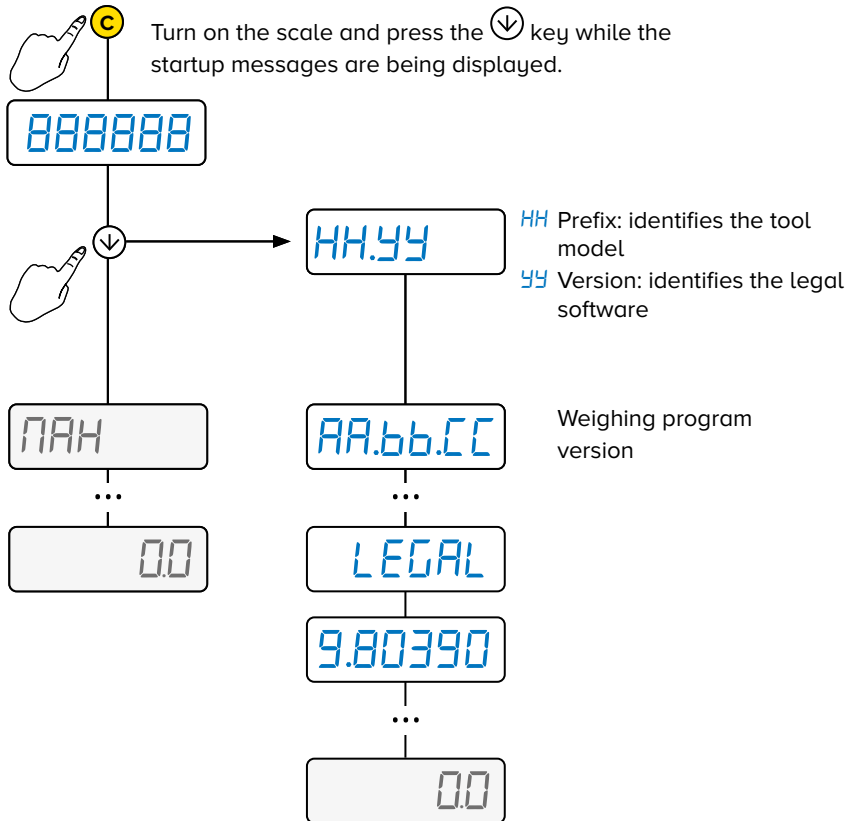



## MAINTENANCE

### Maintenance warnings

---



**WARNING!**

Perform maintenance operations when the machine is switched off and in a safe condition.



**WARNING!**

Maintenance operations must be performed by qualified and authorised personnel.

Machine maintenance includes the operations (inspection, verification, control, adjustment and replacement) that become necessary following normal use.

- During maintenance operations do not release work residues into the environment.
- Only perform the maintenance operations described herein, any unspecified procedures can pose a serious risk to untrained operators and in any case alter the machine's degree of safety.
- Always and only use original spare parts.
- During operation or maintenance, plates and stickers must NOT be removed, hidden, or made illegible.
- The maintenance technicians must wear all the personal protective equipment required for the operation to be carried out.



**WARNING!**

Repair or maintenance operations not contained in this manual may only be carried out with the prior authorisation of ss

No responsibility for damage to persons or property may be attributed to ss for operations other than those described or carried out in ways other than those indicated.

Machine maintenance operations are divided, from the operational point of view, into two main categories:

<b>Scheduled Maintenance</b>	All those operations that the operator must perform, in a preventive manner, to ensure good operation of the machine over time; scheduled maintenance includes inspection, control, adjustment, cleaning and lubrication.
<b>Unscheduled Maintenance</b>	All those operations that the operator must perform when the machine requires it. Unscheduled maintenance includes the overhaul, repair, restoration of nominal operating conditions or the replacement of a faulty, defective or worn out unit.

## Scheduled maintenance

The machine, when delivered to the user, is already adjusted to work properly; however, in order to ensure its proper functioning over time, it is required to carry out periodic and preventive checks and maintenance.

The **scheduled maintenance** includes inspections, checks and operations that, to prevent breakdowns, keep under control:

- the mechanical conditions of the machine,
- the lubrication of the machine,
- the cleaning of the machine.



### WARNING!

Before starting the maintenance operations, place the Pallet Truck on a solid and flat surface.

## Scheduled maintenance table



### IMPORTANT!

Scheduled maintenance operations to be carried out daily are the responsibility of the operator responsible for driving the pallet truck.

Operation	Frequency			
	Daily	Weekly	Monthly	Biannual
Roller and wheel integrity check	◆			
Visual check of the state of the truck frame	◆			
Weight indicator operation check	◆			
Integrated printer operation check (if present)	◆			
Pump operation check	◆			
Acoustic warning check	◆			
Greasing the bearings of the rollers and wheels			◆	
Greasing the tiller control lever guide				◆
Chain greasing with spray				◆
Greasing the lifting system			◆	
Oil level check				◆
Wheel cleaning		◆		
General cleaning of the machine with compressed air and non-pressurised water		◆		
<b>Note:</b> in non-IP models, do not use water on the battery and on the interface.				

## Oil level top-up

### Tank top-up by means of syringe for models with mono-block pump

Check the oil level **every 6 months**.

Only use hydraulic oil (not motor or brake oil) to top-up.

	Oil viscosity:	30 CST at 40°C
	Total volume:	0.3 l

- A. Fully lower the forks.
- B. Unscrew and remove the oil tank closing screw.
- C. If required, add oil through the syringe (not supplied) until the first leak.
- D. Operate the pump several times to release any air from the hydraulic circuit, then lower the forks completely.
- E. Reassemble the closing screw.

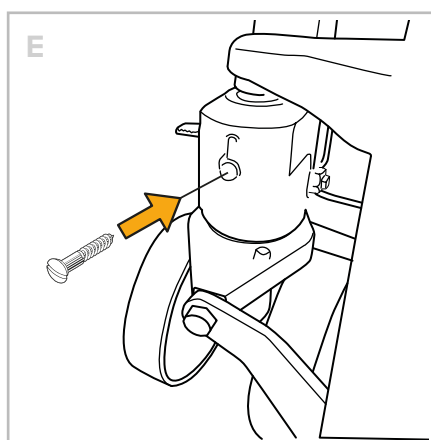
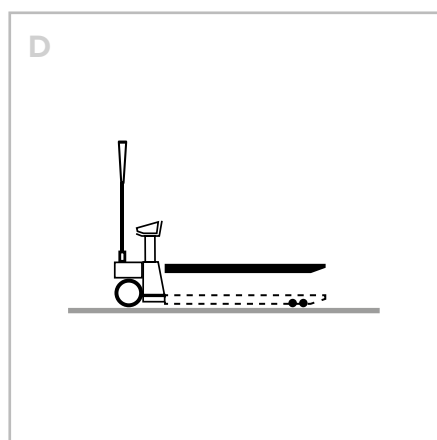
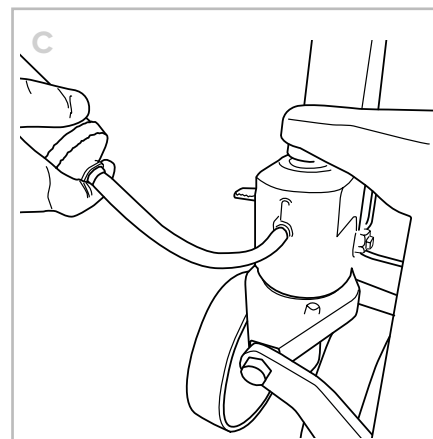
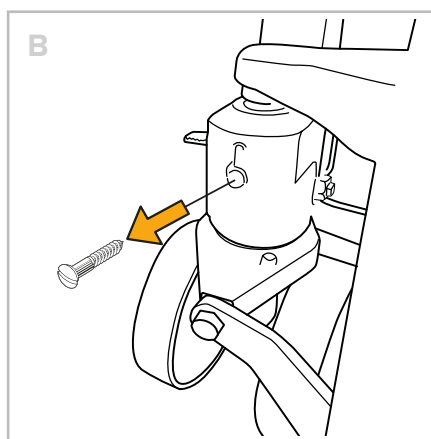
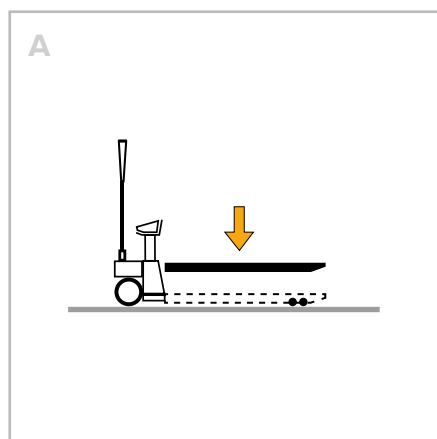

## Unscheduled maintenance

---

For unscheduled maintenance on the machine, contact the Authorised Support Centre.



**WARNING!**

Unscheduled maintenance and repair of the machine are reserved for qualified, instructed and authorised technicians, depending on the manufacturer or authorised service centre.

These operations require in-depth and specialised knowledge of the machines, of the operations required, of the risks involved and of the correct procedures to operate in safety.

## TROUBLESHOOTING CASES

PRINT	The scale does not print	<ul style="list-style-type: none"> <li>• Another printout is already in progress (busy)</li> <li>• Make sure there is a roll in the printer</li> <li>• The printer does not switch on</li> <li>• The weight is unstable (unStAb)</li> <li>• The net or gross weight is negative or insufficient for printing (low)</li> <li>• Underload or overload (_____ or -----) (un.oVEr)</li> <li>• The scale was not unloaded after the last printing (no.0.unS)</li> <li>• You are trying to print a non-approved weight</li> </ul>
TOTALISATION	The scale does not accumulate	<ul style="list-style-type: none"> <li>• Make sure there is a roll in the printer</li> <li>• The printer does not switch on</li> <li>• The weight is unstable (unStAb)</li> <li>• The net or gross weight is negative (L.oB)</li> <li>• Underload or overload (_____ or -----) (un.oVEr)</li> <li>• The scale was not unloaded after the last printing (no.0.unS)</li> <li>• The weight is too low for the weighing operation (L.oB)                             <ul style="list-style-type: none"> <li>- less than 10 divisions for the accumulator modes</li> <li>- less than "Min" for the approved products (shown on the measuring plate)</li> </ul> </li> </ul>
	The scale has lost the total	<ul style="list-style-type: none"> <li>• Switching off the scale causes the accumulated totals to be lost</li> </ul>
TARE	The scale does not tare	<ul style="list-style-type: none"> <li>• The weight is unstable (unStAb)</li> <li>• The gross weight is negative (L.oB)</li> <li>• The weight is insufficient</li> <li>• The weight exceeds the maximum capacity</li> <li>• The tare function has been deactivated</li> <li>• In the event of manual tare, the value exceeds the maximum capacity</li> </ul>
WEIGHING	The scale does not switch on	<ul style="list-style-type: none"> <li>• Make sure the power cable is connected properly</li> <li>• Connect the battery charger and try again. If the instrument continues to malfunction, contact the dealer.</li> </ul>
	The scale switches off suddenly	<ul style="list-style-type: none"> <li>• Automatic switching off active</li> <li>• Low battery</li> <li>• Battery failure</li> <li>• Power supply line failure</li> </ul>
	The scale is not reactive	<ul style="list-style-type: none"> <li>• One of the available energy saving modes has been activated</li> <li>• An unsuitable weighing filter has been selected</li> </ul>
	The scale display switches off and displays a dot	<ul style="list-style-type: none"> <li>• Stand-by mode is active: press a key to reactivate weighing.</li> <li>• Energy saving mode is active: contact the dealer for further details.</li> </ul>
	The scale displays a permanent "ZEro" message	<ul style="list-style-type: none"> <li>• The scale is unable to automatically reset the weight because it exceeds the maximum resettable weight at switch-on.</li> <li>• Unload the scale and try again. If the scale continues to have the same problem even when there is nothing on it, contact the dealer.</li> </ul>

	<b>The weight is unstable</b>	<ul style="list-style-type: none"> <li>• Check whether the weighing filter is active.</li> <li>• If the support surface is subjected to vibrations from machinery or moving vehicles, move the scale onto another surface and try again.</li> </ul>
PIECE COUNTER	<b>The scale does not carry out sampling</b>	<ul style="list-style-type: none"> <li>• The weight is unstable (<i>Err. Plat</i>)</li> <li>• The weight is insufficient, add more pieces and try again (<i>Error</i>)</li> </ul>
CARPENTRY AND TRACTION TILLER	<b>The machine does not start</b>	<ul style="list-style-type: none"> <li>• Low battery</li> <li>• Burned fuse</li> <li>• Broken key</li> <li>• Electrical system short circuit</li> <li>• Damaged traction control board</li> <li>• Damaged user interface board</li> </ul>
	<b>The forks do not rise</b>	<ul style="list-style-type: none"> <li>• The lever is not in position B - Raising</li> <li>• Valve sphere does not close</li> <li>• Adjustment screw displaced</li> <li>• Piston seals worn or damaged</li> <li>• There is no oil in the tank</li> </ul>
	<b>The forklift does not brake</b>	<ul style="list-style-type: none"> <li>• Low braking torque</li> </ul>
	<b>The battery does not charge</b>	<ul style="list-style-type: none"> <li>• The battery is not connected to the charger</li> <li>• The key is not inserted in the battery</li> <li>• The charger is not connected correctly</li> <li>• Battery charger fuse broken</li> </ul>
	<b>The forks do not remain raised</b>	<ul style="list-style-type: none"> <li>• Worn cylinder seals</li> <li>• Dirty pressure valve</li> </ul>

## Error messages

MESSAGE	DESCRIPTION	SOLUTION
<i>buSy</i>	Another printout is already in progress	Wait for the printout in progress to be finished and try again.
<i>unStAb</i>	The weight is unstable	Check the weighing filter. If the support surface is subjected to vibrations from machinery or moving vehicles, move the scale onto another surface and try again.
<i>LoH</i>	The net or gross weight is negative or insufficient for printing	Add weight and try again.
<i>undEr</i>	Underload	Load the scale and restore a valid weight condition. If the problem persists, contact customer service.
<i>oVEr</i>	Overload	Unload the scale and restore a valid weight condition. If the problem persists, contact customer service.
<i>no.O.unS</i>	The scale was not unloaded after the last printing	Completely unload the scale, making sure <b>→0←</b> lights up. Load the weight and try again.
<i>Err.NoSt</i>	The weight is unstable	Wait for stability (the <b>~</b> light) and try again.
<i>Error</i>	In piece counting mode, the weight is insufficient for proper sampling.	Add more pieces and try again.
<i>t iLt</i>	Angle error.	Move the pallet truck to a flat surface and try again.













A RICE LAKE WEIGHING SYSTEMS COMPANY

**HEAD OFFICE**

Via Della Fisica, 20  
41042 Spezzano di Fiorano, Modena - Italy  
Tel. +39 0536 843418 - Fax +39 0536 843521

**SERVICE ASSISTANCE**

Via Dell'Elettronica, 15  
41042 Spezzano di Fiorano, Modena - Italy  
Tel. +39 0536 921784 - Fax +39 0536 926654

[www.diniargeo.com](http://www.diniargeo.com)

Authorised service centre stamp

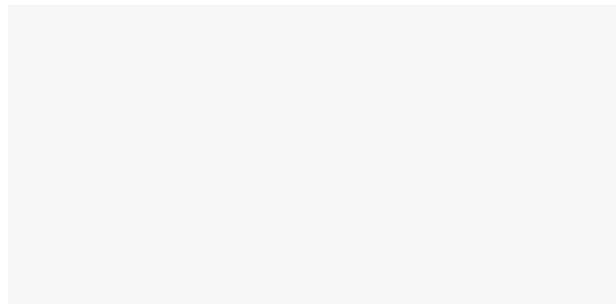

The information in this document is approximate and can be subject to variations without prior notice by Dini Argeo, with respect of the norms in force. The official technical data is available in the updated version on the [www.diniargeo.com](http://www.diniargeo.com) website or by contacting the Dini Argeo Customer Service.